



Alumil
Building excellence every day



Alumil  **SMARTIA**
M450



CONTENTS

SMARTIA M450

DESIGN PHILOSOPHY & CHARACTERISTICS	4
SENSE OF FREEDOM	8
ATTENTION TO DETAIL	10
EXPLOITING EVERY CONTEMPORARY NEED	12
SECTIONS	14
INSTALLATION	24
APPLICATIONS	26
PERFORMANCE	27



SMARTIA M450

represents the next generation of advanced systems for minimal lift & slide and regular sliding doors.

Maximum view,
limitless solutions.

SMARTIA M450
meets the demanding
requirements of...

contemporary residences for
high thermal insulation and
modern aesthetics.



- Basic system's depth 45 mm.
- Minimal and innovative design with 25 mm of visible aluminium face width at the interlocking profile, both for lift & slide and sliding typologies.
- High thermal insulation with patented thermally efficient typologies.
- Easy to clean frame, with invisible water evacuation and less visible depth.
- It is ideal for new buildings and renovations, as it provides flexibility of construction and a wide variety of typologies.

Alumil SMARTIA
M450

TECHNICAL

CHARACTERISTICS



VISIBLE ALUMINIUM FACE WIDTH	124,5 mm LIFT & SLIDE 114 mm SLIDING
FRAME HEIGHT	45 mm
FRAME WIDTH	113 mm
SASH HEIGHT	88 mm LIFT & SLIDE 77,5 mm SLIDING
SASH WIDTH	45 mm
INTERLOCKING PROFILE WIDTH	25 / 91,5 mm LIFT & SLIDE 25 / 81 mm SLIDING
SASH WEIGHT	UP TO 200 KG LIFT & SLIDE UP TO 180 KG SLIDING
GLAZING	27 UP TO 36 mm
INSULATION	POLYAMIDES 40 & 24 mm

Minimal design that enhances **natural light**,

thanks to the narrow interlocking profile of **only 25 mm** visible aluminium face width.

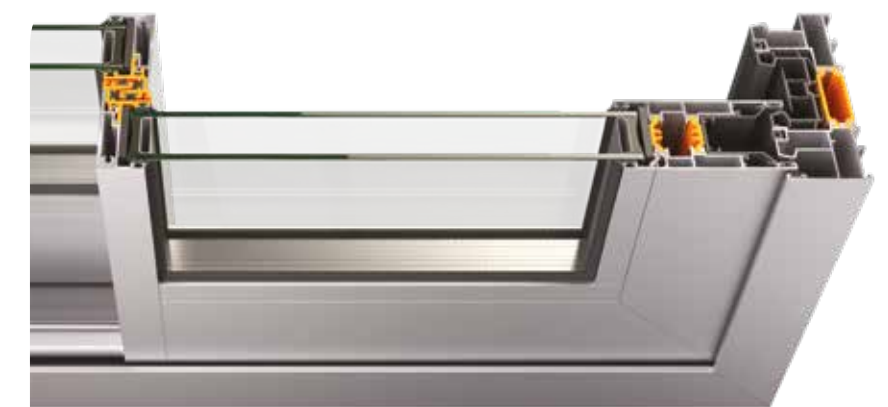

A unique and innovative solution for lift & slide typologies with the narrowest interlocking profile.



The narrow interlocking profile is available for both lift & slide and regular sliding typologies.

Alumil SMARTIA
M450

ATTENTION

Narrow depth into the frames due to the **specially designed PVC profiles**. They are installed either in the bottom frame or perimetrically to cover water evacuation and make the cleaning process easier.

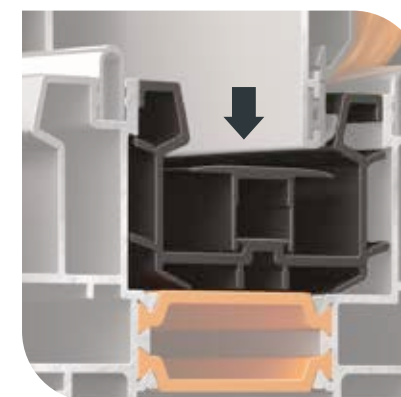

High thermal insulation performance, achieved with fiberglass reinforced polyamides of **40mm & 24mm width**. Along with the PVC profiles, they contribute to green buildings design, emphasizing on energy & money saving.

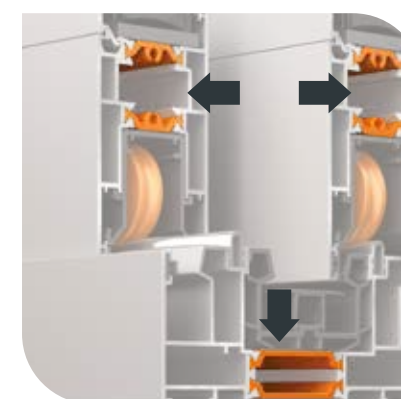

The system's sliding mechanism provides up to 4 locking points and optional cylinder use, **offering high safety & top functionality**.

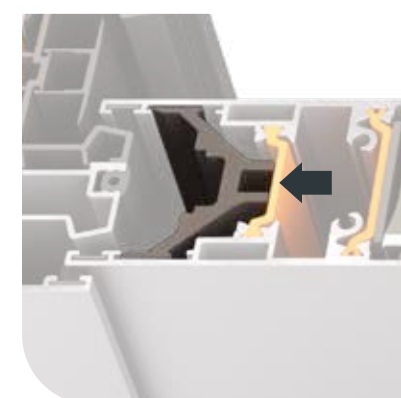

High quality gaskets **with soft touch** for lift & slide typologies, contribute significantly to the system's overall performance.

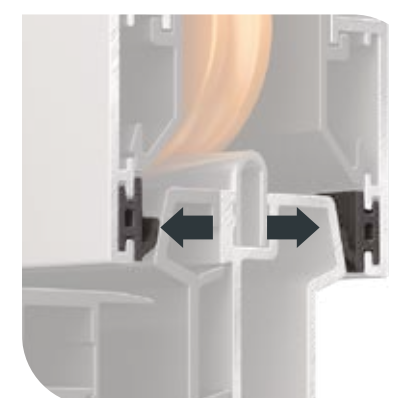

TO DETAIL

High quality PVC profiles with **UV-protection** that preserve their durability and texture under intense exposure to solar radiation.

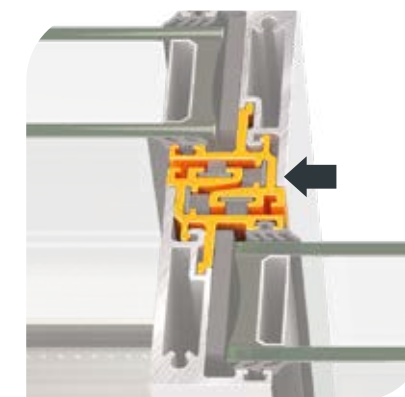

The door sash glides **easily and quietly** on the rails made of stainless steel AISI 316L.

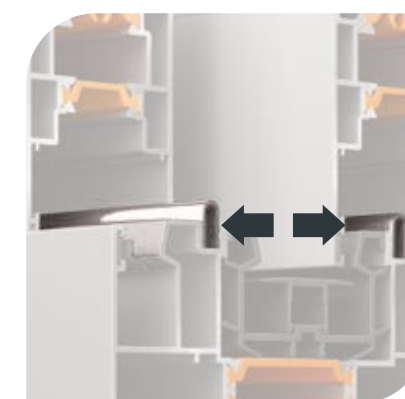

The system's lift & slide mechanism allows the sash to open and close easily - even wider and heavier sashes, **offering high functionality & smooth gliding**.

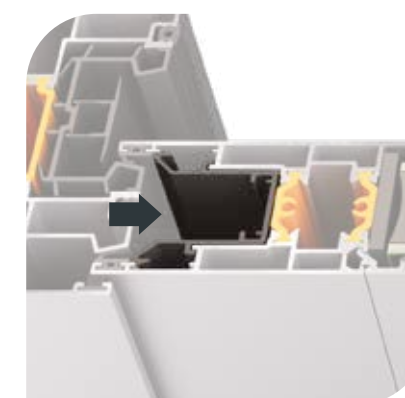

High quality brushes **with triple membrane** for regular sliding typologies, contribute significantly to the system's overall performance.

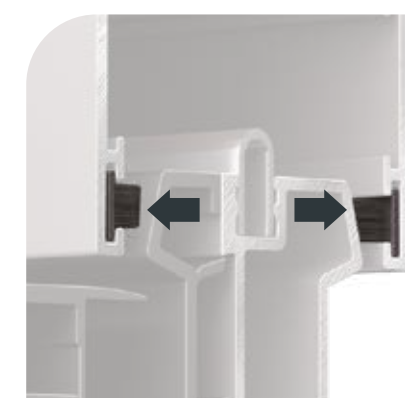

The system SMARTIA M450 is characterized by its flexibility as it offers 4 different sashes that cover every construction need. Less aluminium frame, robust profiles, ease of

fabrication, regardless of what the requirement is, there is an ideal solution to fulfill it.

SASH PROFILES				
	M4542	M4544	M4540	M4538
MECHANISM				
LIFT & SLIDE	●			
SLIDING	●	●	●	●
LOCKING POINTS				
MULTIPLE	●	●	●	●
SINGLE				
INTERLOCKING PROFILE				
STANDARD	●	●	●	●
NARROW 25 mm	●	●	●	
GLAZING				
GLAZING BEAD	●	●		
GLAZING WIDTH	27-32	27-32	27-36	36
PERFORMANCE				
U _f	2,7	2,7	2,7	2,6

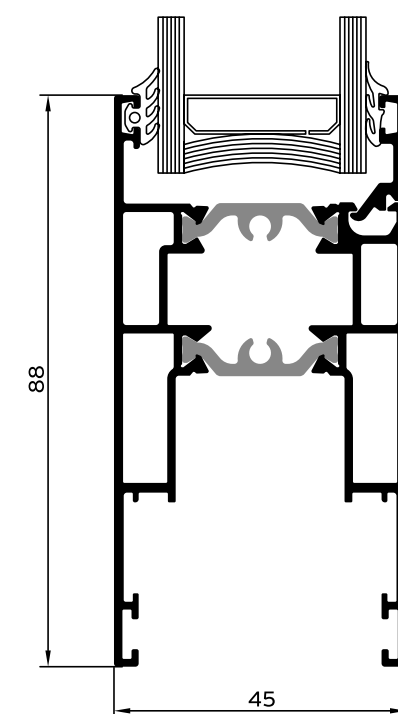
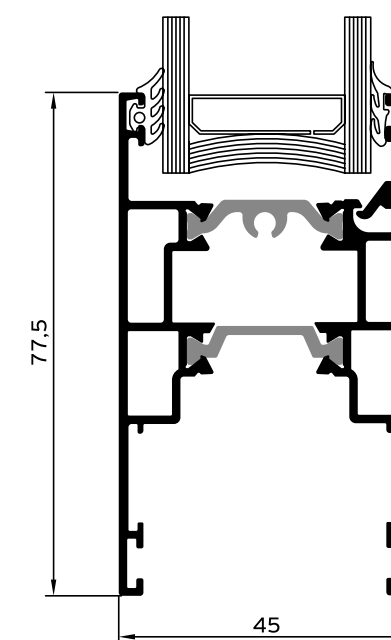
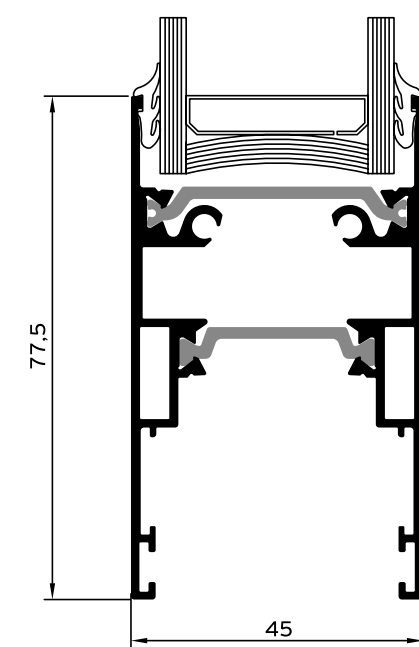
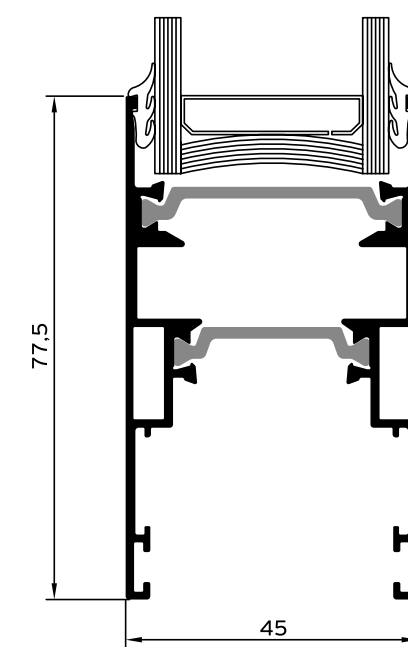
EXPLOITING
EVERY CONTEMPORARY NEED

M4542

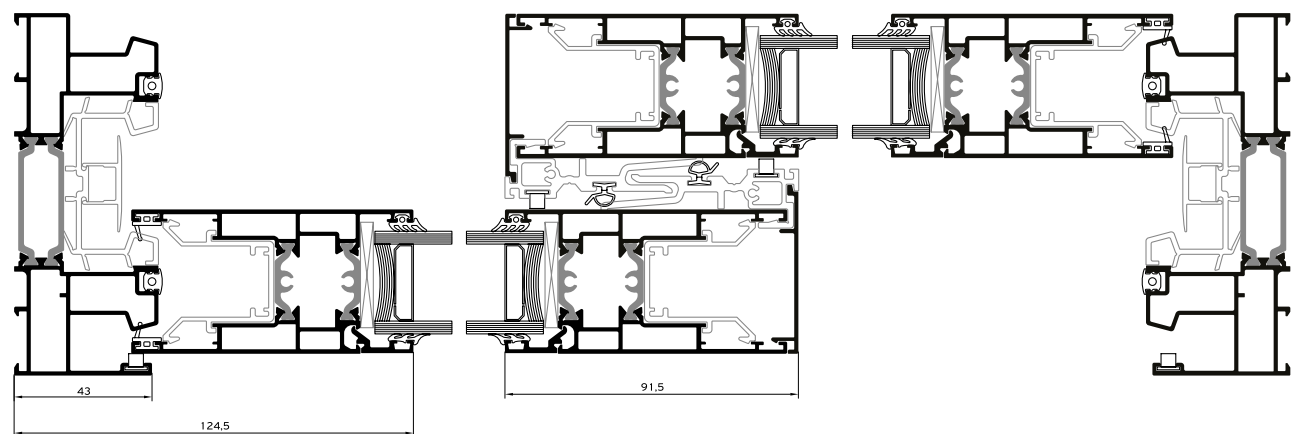
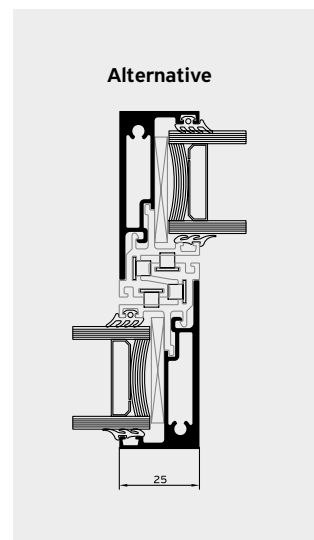
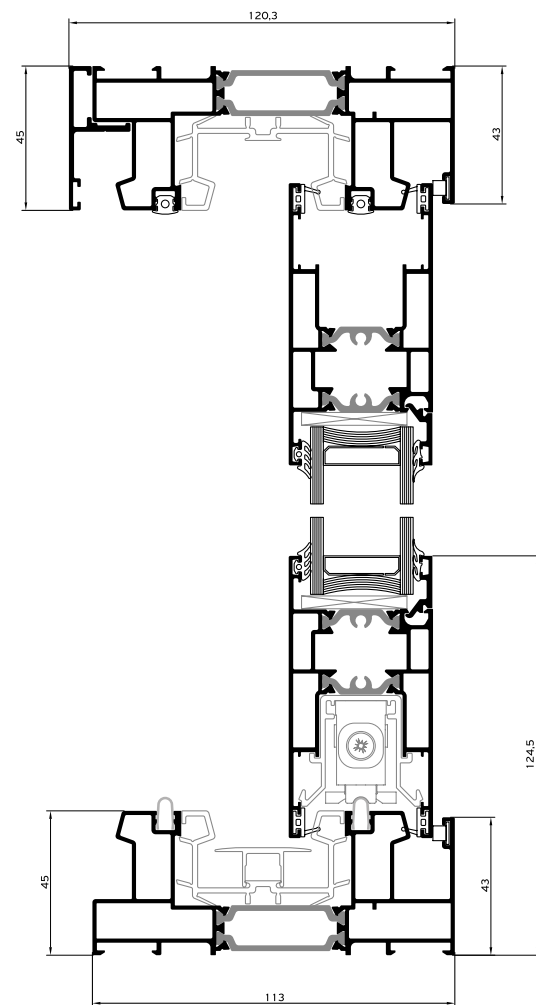
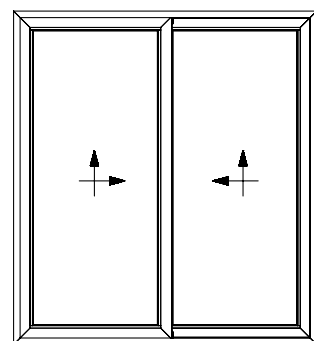
M4544

M4540

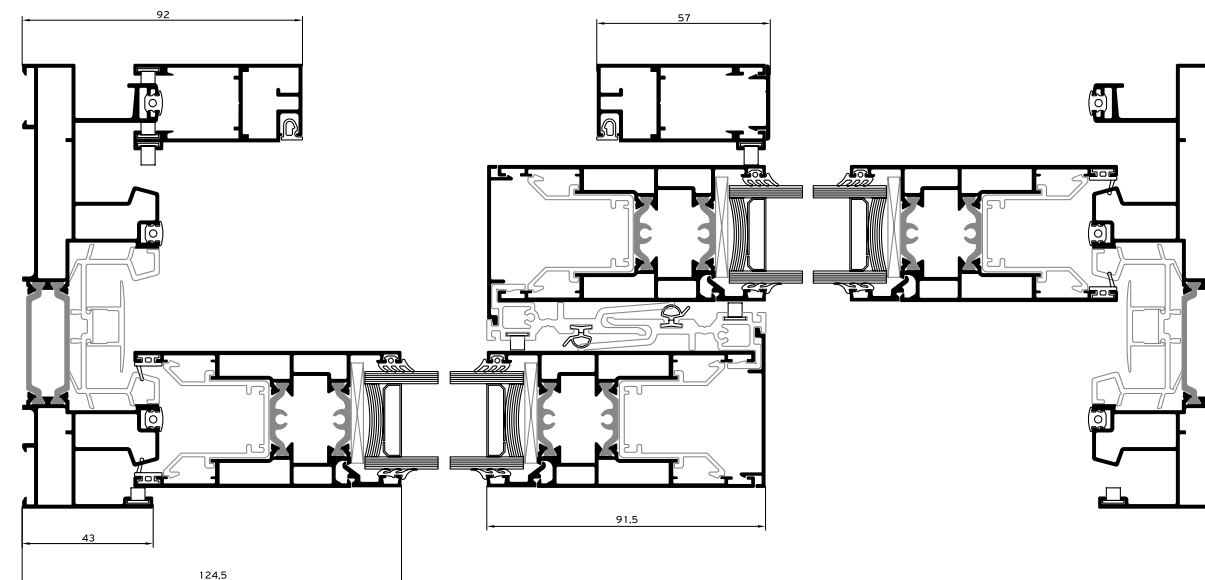
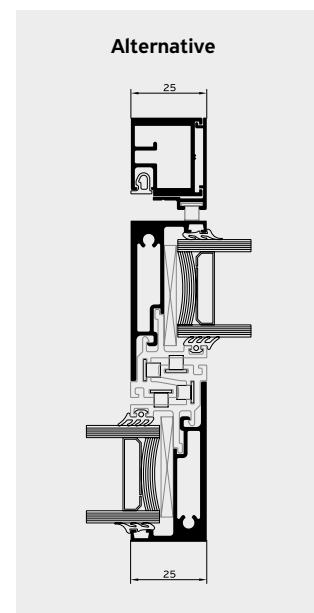
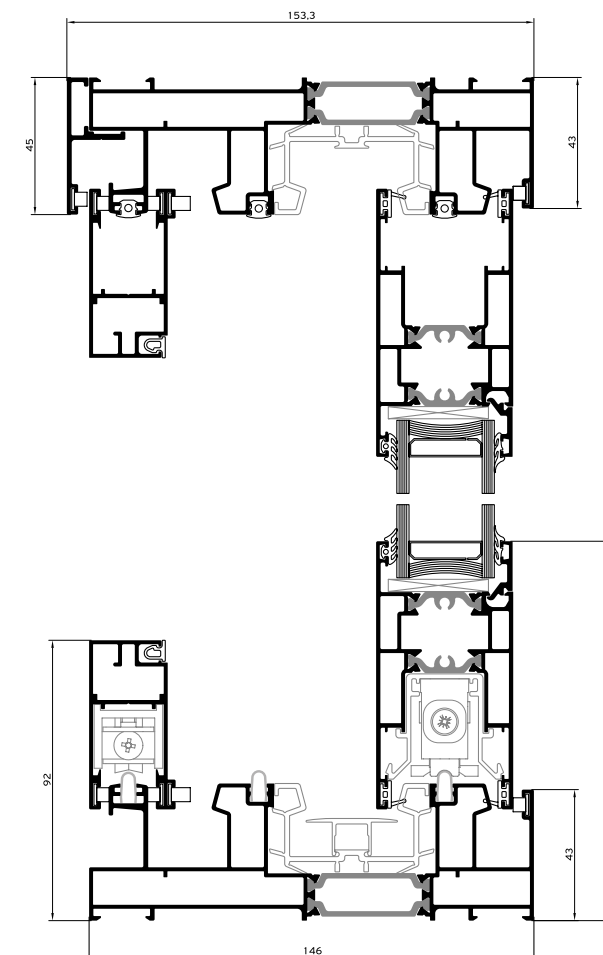
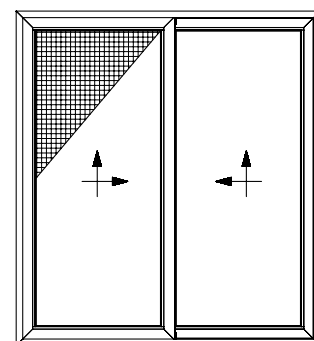
M4538

2 Sashes / 2 Track



2 Sashes / 2 Track / Flyscreen



2 Sashes / 2 Track

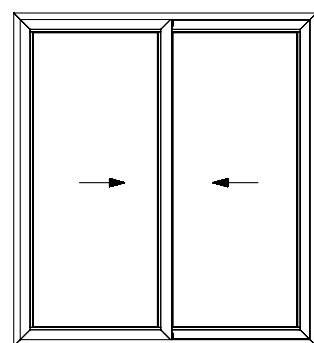

FOR SLIDING TYPOLOGIES

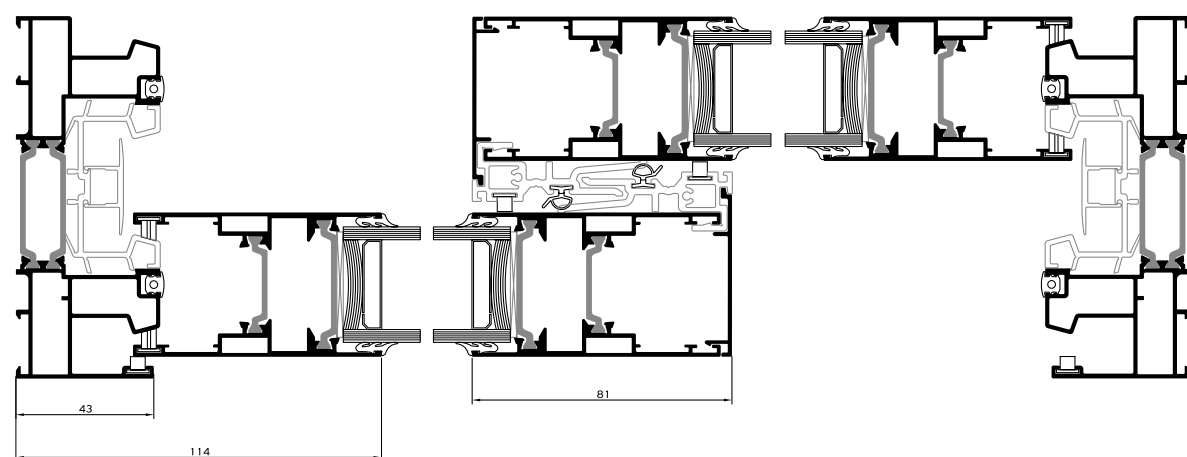
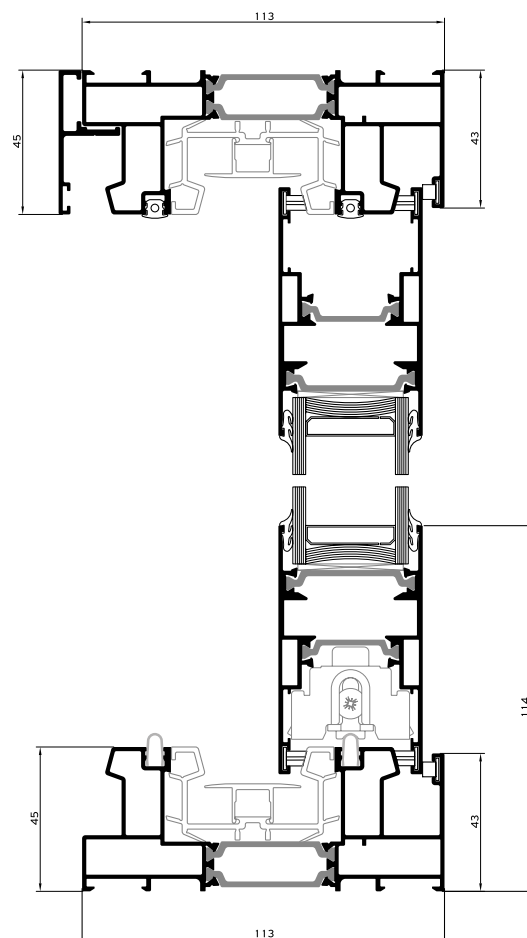

2 Sashes / 2 Track

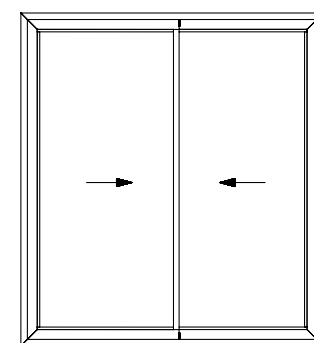

FOR SLIDING TYPOLOGIES

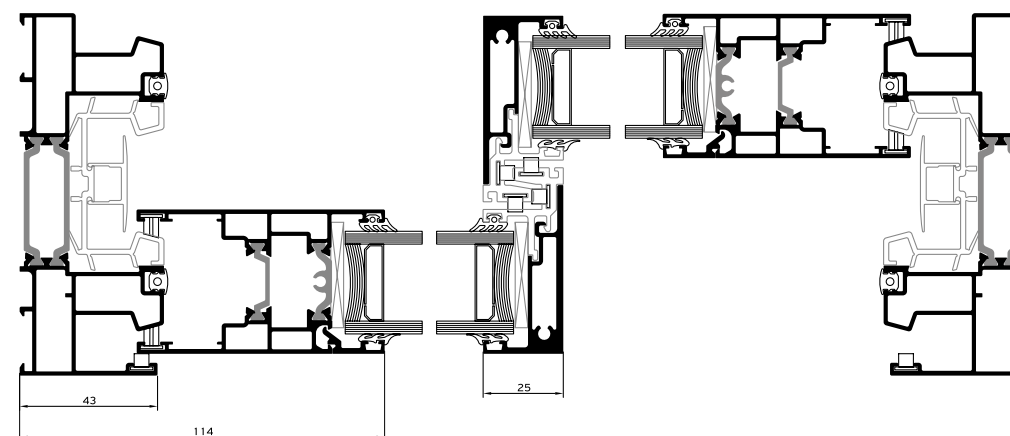
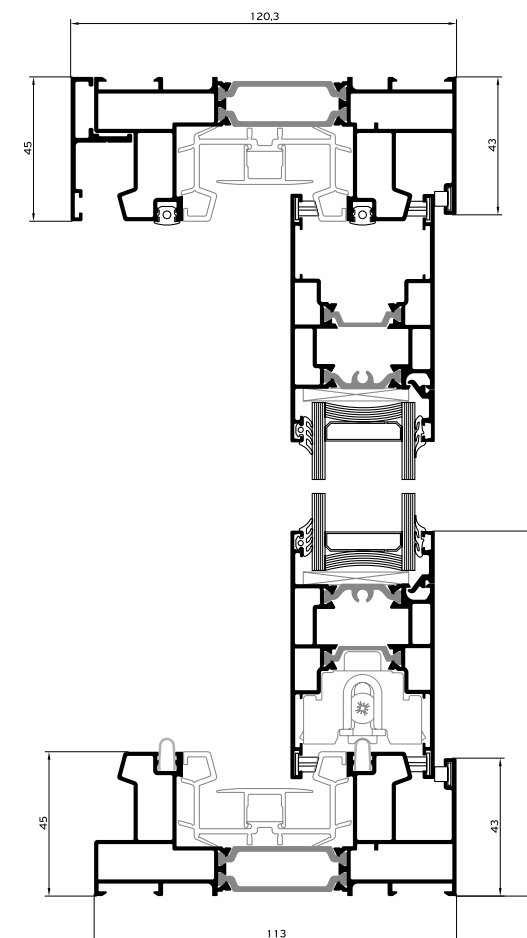

3 Sashes / 3 Track

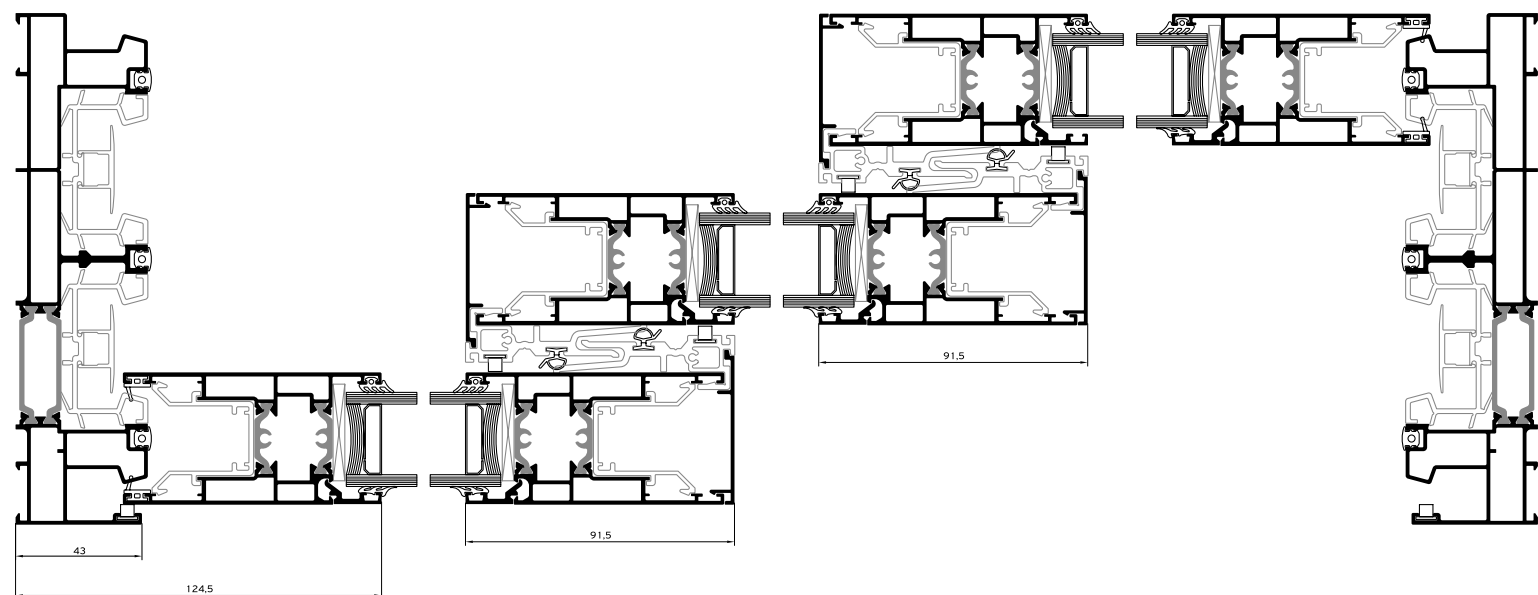
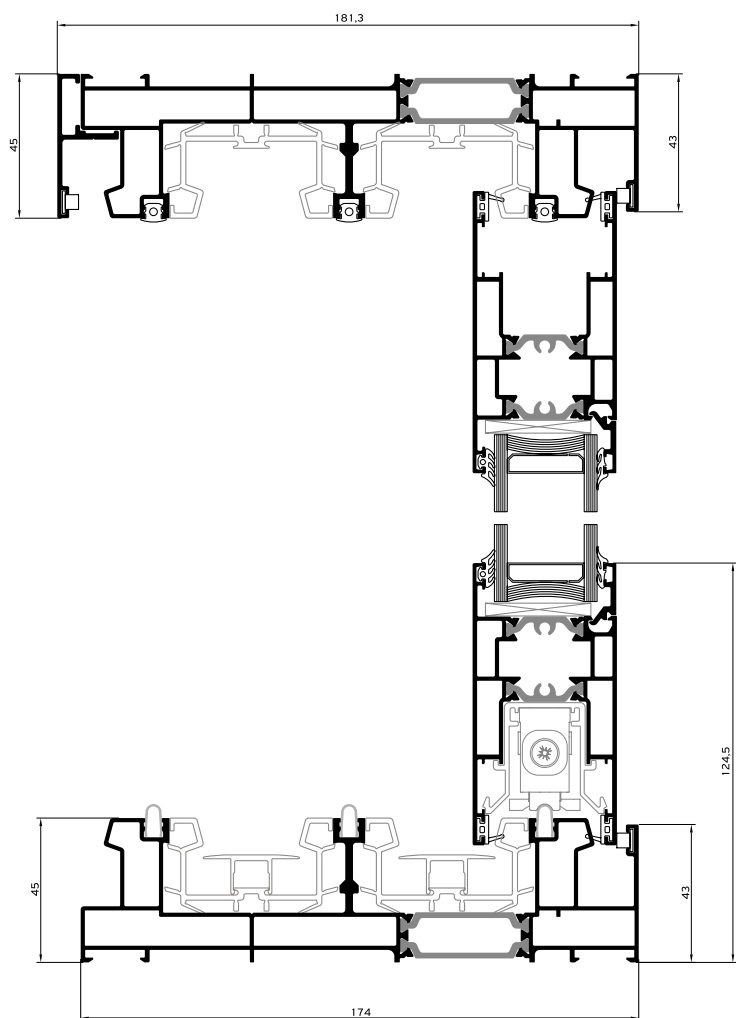
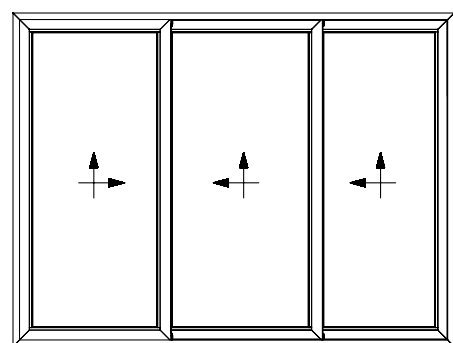

3 Sashes / 3 Track

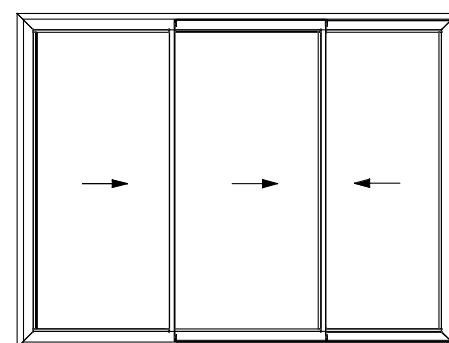

FOR SLIDING TYPOLOGIES

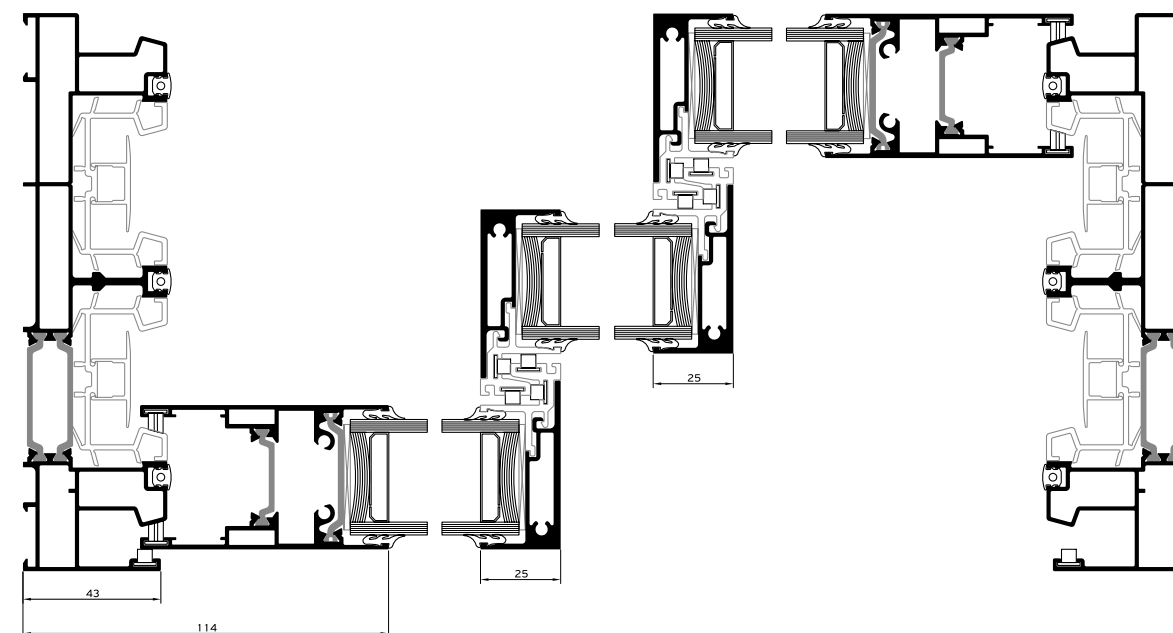
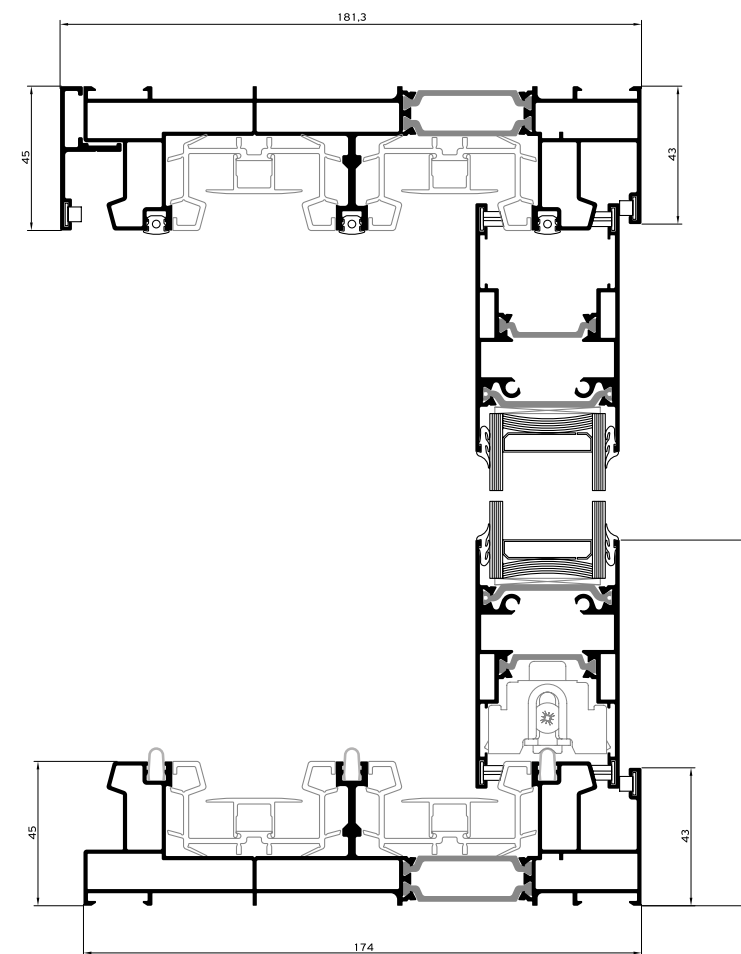

4 Sashes / 2 Track

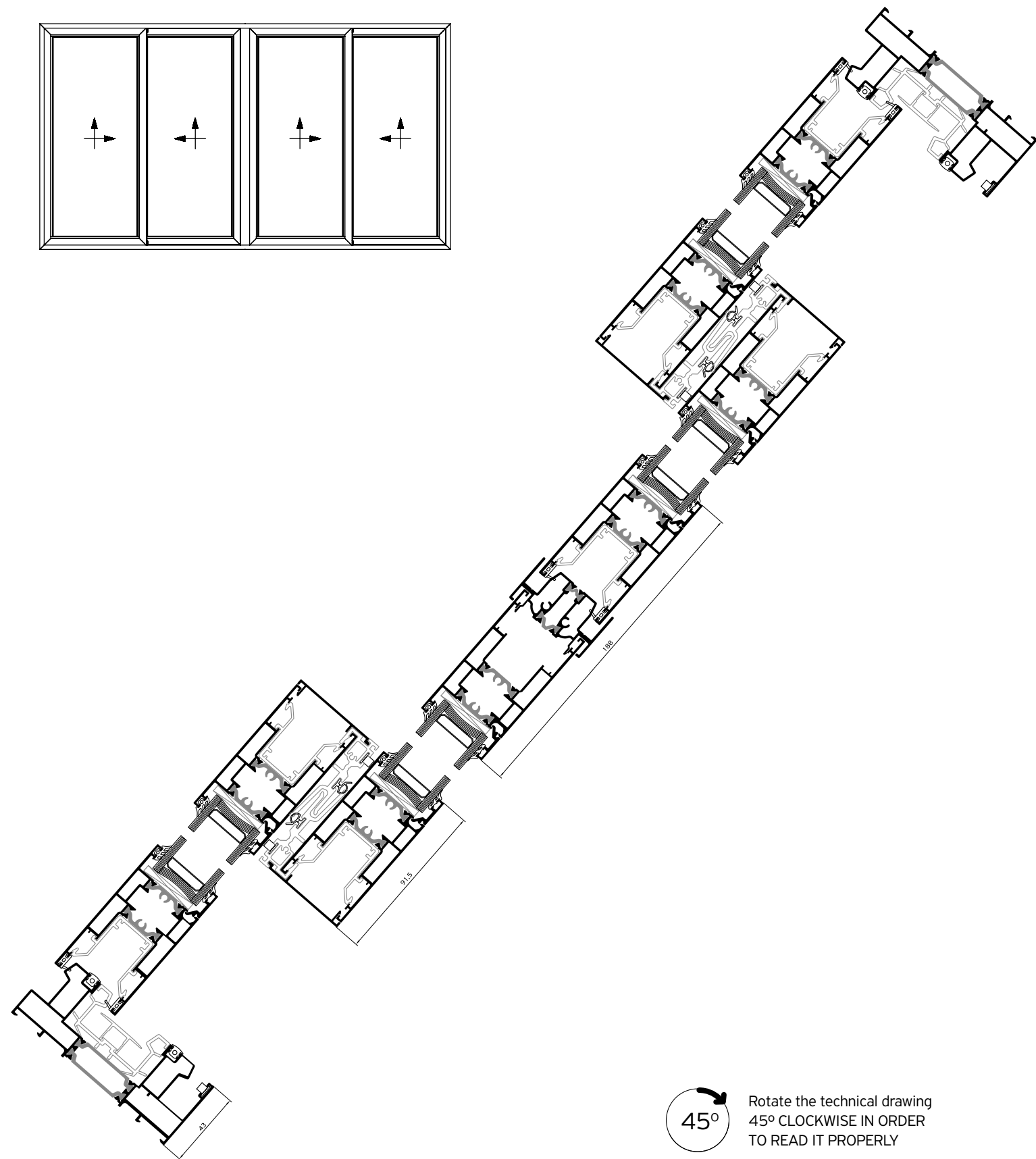
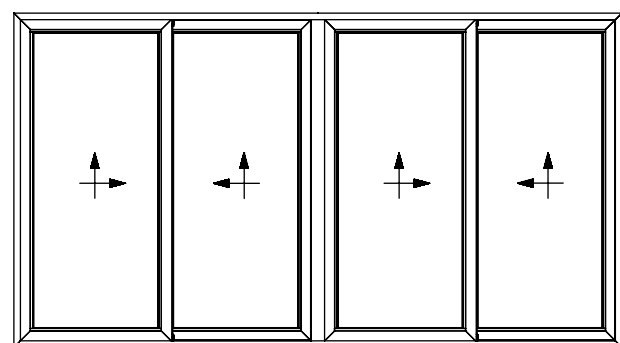

45° Rotate the technical drawing
45° CLOCKWISE IN ORDER
TO READ IT PROPERLY

2 Sashes / Flyscreen / Shutter

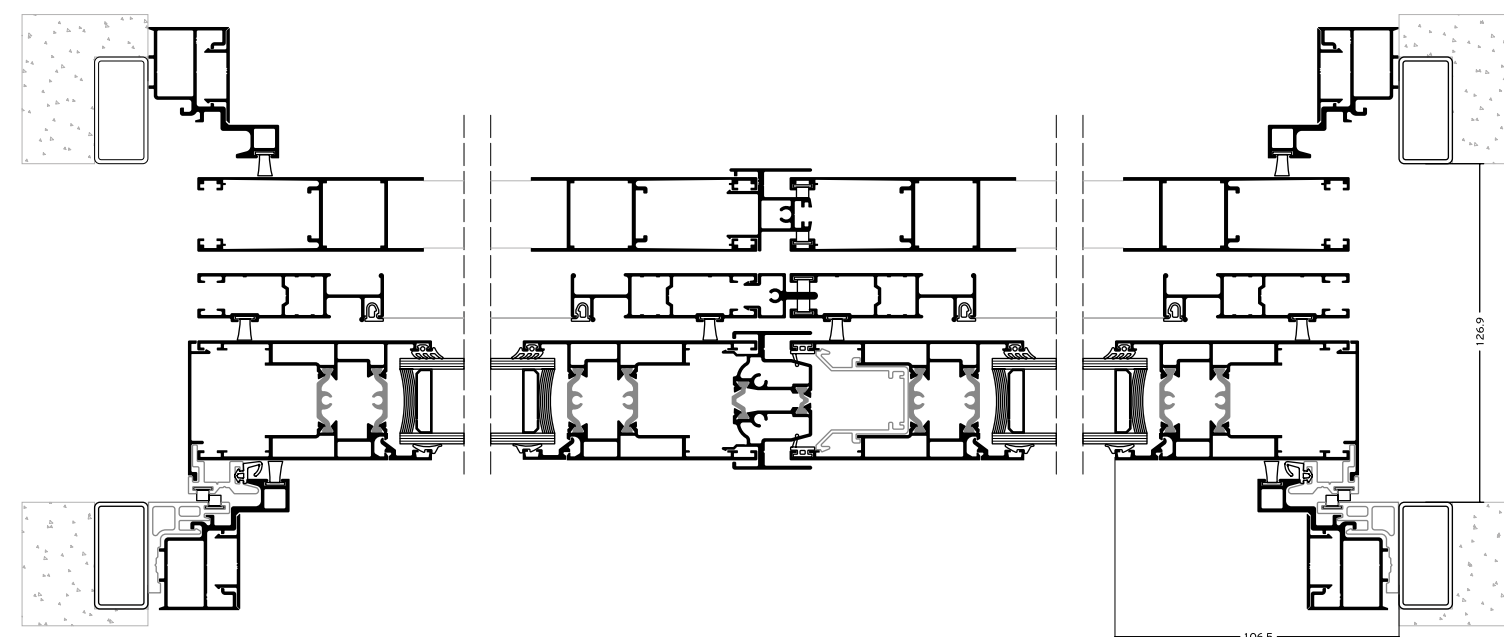
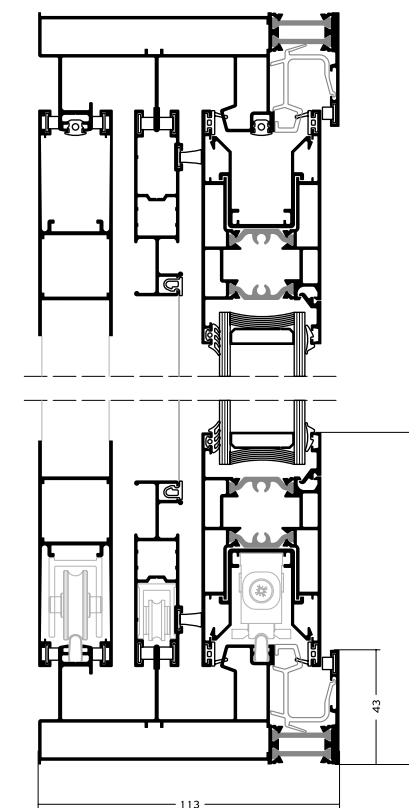
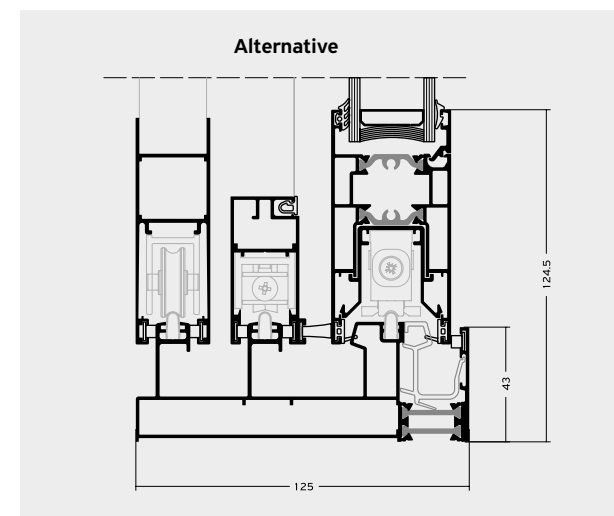
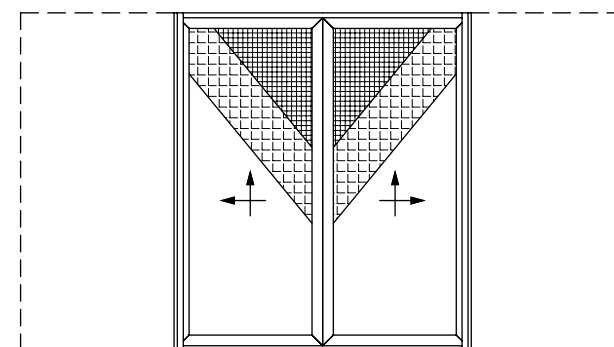





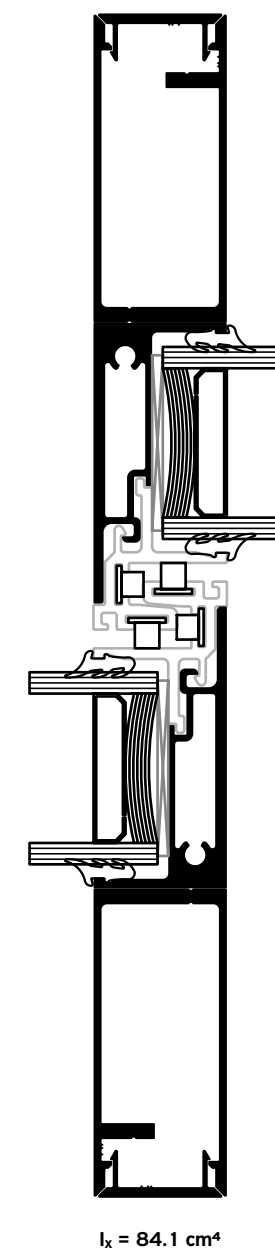
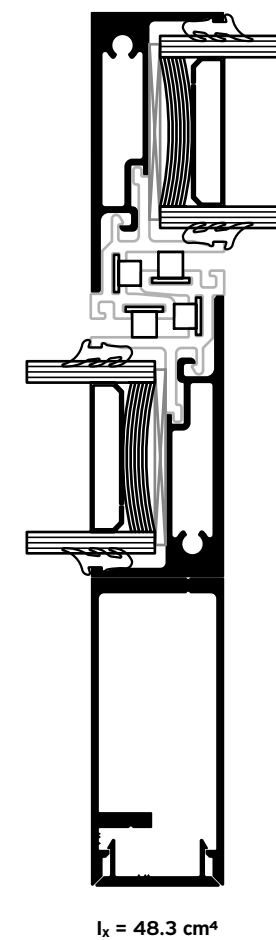
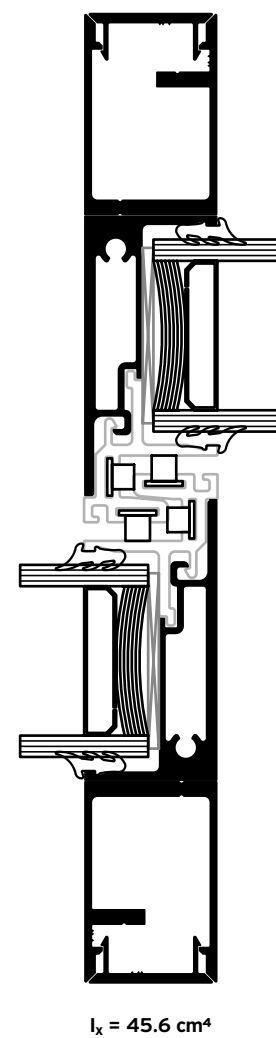
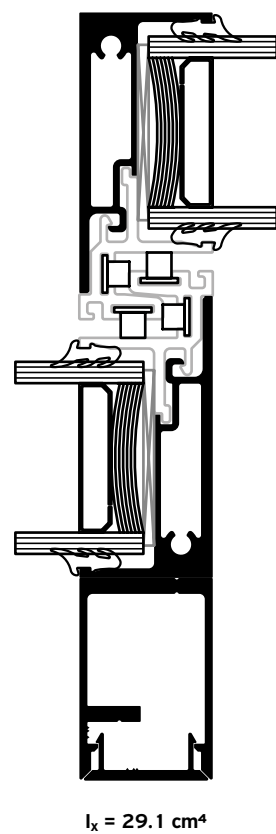
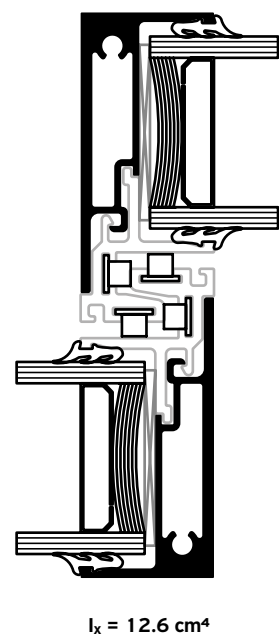
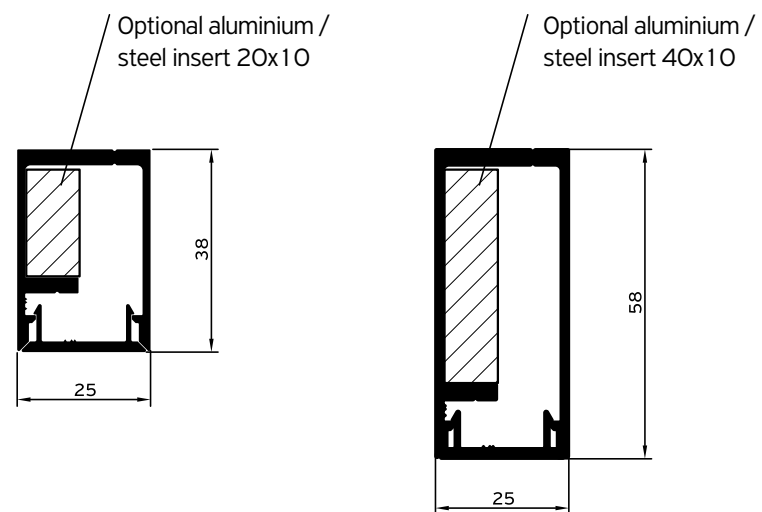





STIFFENERS

Extra reinforcement at the interlocking profile apart from aesthetics and functionality, offers robustness to the structure and resistance to wind loads for higher sashes



Installation

-  PRECOMPRESSED MULTI-FUNCTION SEALING TAPE
-  BACKER ROD
-  HYBRID SEALANT OR NEUTRAL SILICONE
-  STYRODUR HIGH DENSITY BOARD
-  MARBLE
-  POLYURETHANE FOAM
-  POLYSTYRENE
-  WALL CONSTRUCTION
-  WALL FINISH
-  REINFORCED CONCRETE
-  AIR WATER VAPOR BARRIER TAPE

SIDE SECTION

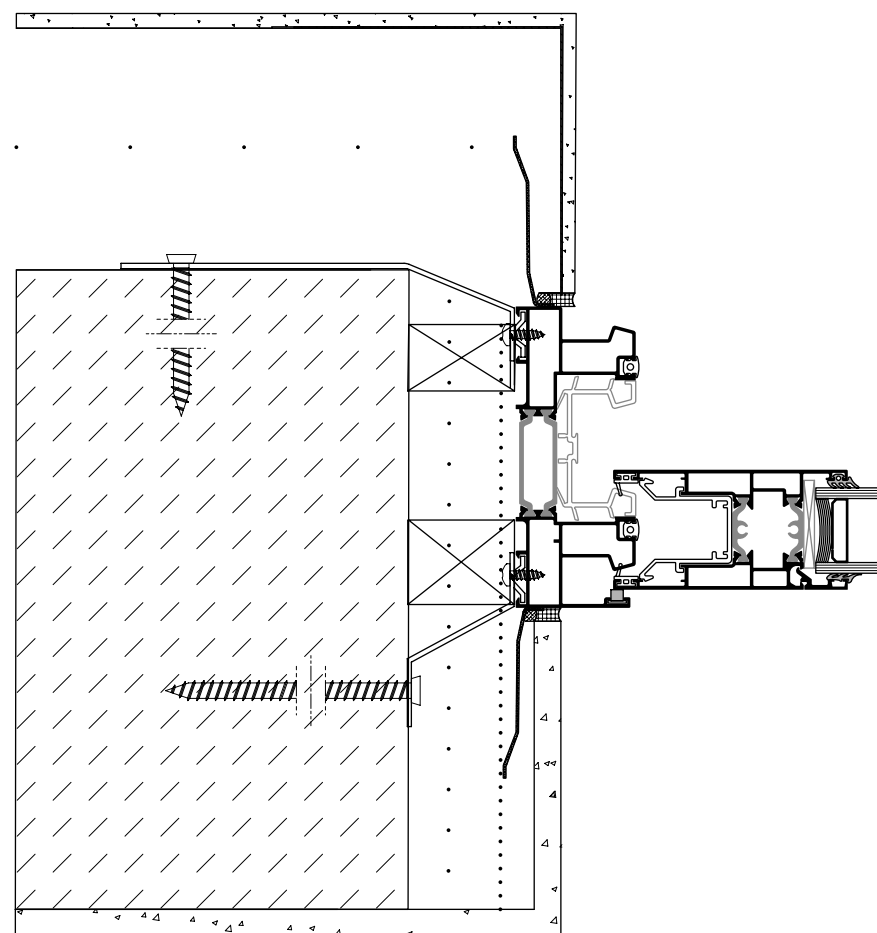

TOP SECTION

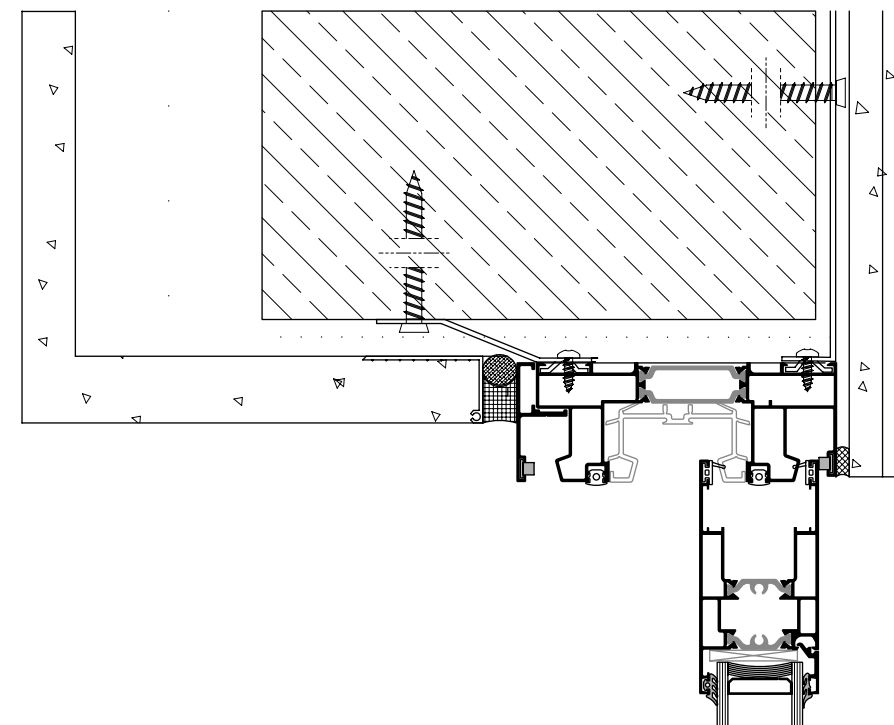

BOTTOM SECTION

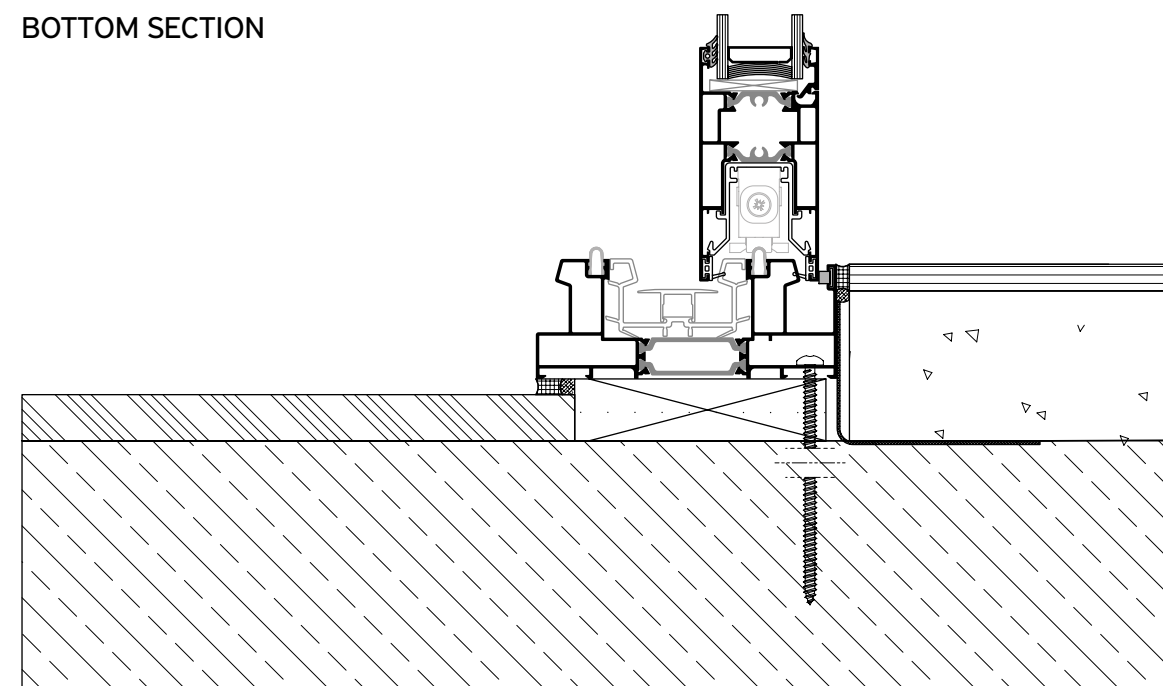

Applications

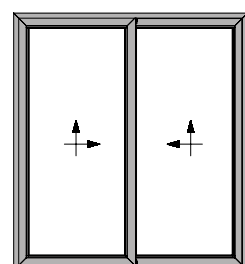

2 SASHES / 2 TRACK

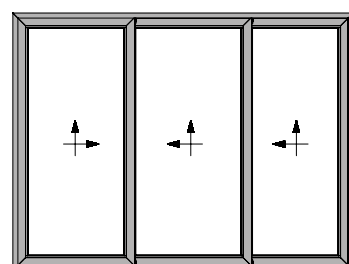

3 SASHES / 3 TRACK

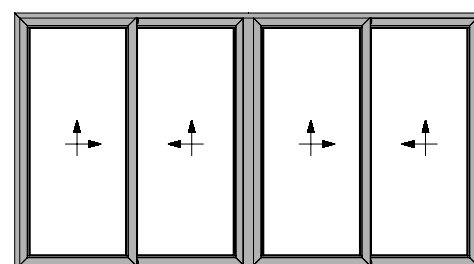

4 SASHES / 2 TRACK

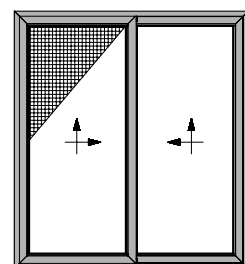

2 SASHES / 2 TRACK / FLYSCREEN

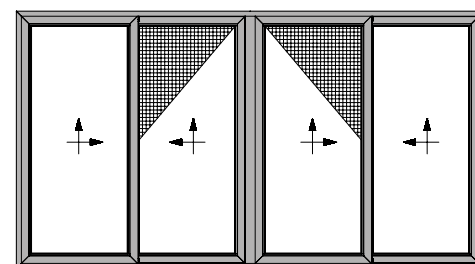

4 SASHES / 2 TRACK / FLYSCREEN

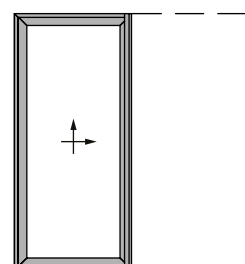

1 SASH / 1 TRACK

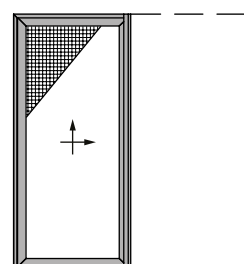

1 SASH / FLYSCREEN

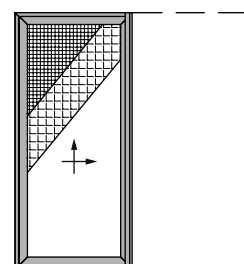

1 SASH / FLYSCREEN / SHUTTER

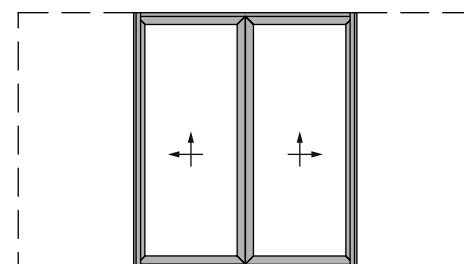

2 SASHES / 1 TRACK

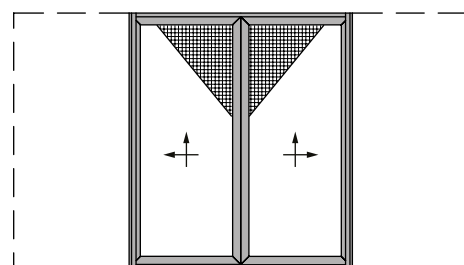

2 SASHES / FLYSCREEN

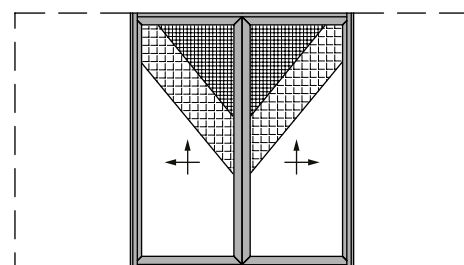

2 SASHES / FLYSCREEN / SHUTTER

ALL TYPOLOGIES ARE AVAILABLE BOTH FOR LIFT & SLIDE AND FOR SLIDING TYPOLOGIES

Table of performance

CERTIFICATION



WATER TIGHTNESS
EN 12208



AIR PERMEABILITY
EN 12207



WIND LOAD RESISTANCE
MAX TEST PRESSURE
EN 12210



WIND LOAD RESISTANCE
TO FRONTAL DEFLECTION
EN 12210

CLASSIFICATION

1A (0 Pa)	2A (50 Pa)	3A (100 Pa)	4A (150 Pa)	5A (200 Pa)	6A (250 Pa)	7A (300 Pa)	8A (450 Pa)	9A (600 Pa)
1 (150 Pa)		2 (300 Pa)		3 (600 Pa)		4 (600 Pa)		
1 (400 Pa)		2 (800 Pa)		3 (1200 Pa)	4 (1600 Pa)		5 (2000 Pa)	
A (≤ 1/150)				B (≤ 1/200)			C (≤ 1/300)	

THERMAL PERFORMANCE

DIMENSIONS IN MM
(W x H)

U_w in W/m²K
(U_g = 0,8)

U_w in W/m²K
(U_g = 1,0)

U_w in W/m²K
(U_g = 1,1)

2 SASHES / 2 TRACK (SLIDING)	2300 x 2180	1,36	1,51	1,59
2 SASHES / 2 TRACK (LIFT & SLIDE)	2300 x 2180	1,43	1,58	1,66

www.alumil.com

DISCOVER MORE:



**ALUMIL
HEAD OFFICES
& SHOWROOM - THESSALONIKI**

GOGOUSI 8, EFKARPIA
THESSALONIKI - GR 56429
TEL.: +30 2313011000
FAX.: +30 231692473
E-MAIL.: info@alumil.com

**ALUMIL
HEADQUARTERS**

KILKIS INDUSTRIAL AREA
KILKIS - GR 61100
TEL.: +30 23410 79300
FAX.: +30 23410 71988
E-MAIL.: info@alumil.com



**ALUMIL
HEAD OFFICES
& SHOWROOM - THESSALONIKI**

GOGOUSI 8, EFKARPIA
THESSALONIKI - GR 56429

TEL.: +30 2313 011000
FAX.: +30 2310 692473
EMAIL.: info@alumil.com

**ALUMIL
HEADQUARTERS**

KILKIS INDUSTRIAL AREA
KILKIS - GR 61100

TEL.: +30 23410 79300
FAX.: +30 23410 71988
EMAIL.: info@alumil.com

www.alumil.com

Alumil

EN NOV 2022