



Alumil
Building excellence every day



Alumil  **SMARTIA**
S560



CONTENTS

SMARTIA S560

DESIGN PHILOSOPHY & CHARACTERISTICS	4
SENSE OF FREEDOM	8
ATTENTION TO DETAIL	10
FOCUS ON SAFETY	12
SECTIONS	14
APPLICATIONS	26
PERFORMANCE	28
REFERENCE PROJECTS	30



SMARTIA S560

The smartest solution
for Lift & Slide or
regular sliding windows
and patio doors.

Each new situation
requires a new architecture.

Alumil SMARTIA
S560

ALUMIL's **thermally insulated**
Lift & Slide or sliding system
SMARTIA S560

presents the ideal solution for
robust constructions, offering high
functionality and **top performance**.

DESIGN PHILOSOPHY

@ CHARACTERISTICS



- Slim profile with a basic system depth of 56 mm.
- Maximum natural light ensured by a 49 mm of visible aluminium face width at the interlocking profile.
- Convenient access provided by the low threshold, making it perfect for renovations (version SMARTIA S560 LT).
- Versatile construction options, offering both Lift & Slide and regular sliding doors with the same design.
- Enhanced water drainage with extra concealed profiles available.
- Wide variety of typologies, making it an ideal choice for renovations and hotel solutions.

Alumil SMARTIA
S560



TECHNICAL

CHARACTERISTICS



VISIBLE ALUMINIUM FACE WIDTH	108,5 / 122,5 mm
FRAME HEIGHT	31 / 45 mm
FRAME WIDTH	136 mm
SASH HEIGHT	86 / 96,5 mm
SASH WIDTH	56 mm
INTERLOCKING PROFILE WIDTH	49 / 96 / 106,5 mm
SASH WEIGHT	UP TO 90, 200, OR 300 KG LIFT & SLIDE UP TO 180 KG SLIDING
GLAZING	FROM 22 TO 45 mm
INSULATION	POLYAMIDES 24 mm & 16 mm, PVC, INSULATION FOAM

SENSE

OF FREEDOM

Modern and elegant aesthetics

with only **49 mm** visible face width at the interlocking profile

THE ALTERNATIVE VERSION FEATURING A LOW THERMALLY INSULATED THRESHOLD OF **JUST 31 MM**, PROVIDES EFFORTLESS AND SECURE ACCESS, MAKING THE SYSTEM AN **IDEAL CHOICE FOR RENOVATION PROJECTS.**



SMARTIA S560
Standard Threshold



SMARTIA S560 LT
Low Threshold



Alumil SMARTIA
S560

ATTENTION

TO DETAIL



Thermally insulated profiles with **glass-reinforced polyamides PA 6.6** incorporated in both the frame and the sash with a 24 mm and 16 mm width.



Wide variety of stiffeners for reinforcement at the interlocking position internally and/or externally, according to the wind load specs of each project.



The special design of **aluminium glazing support** transfers loads directly to the rollers, maximising the functionality and the smooth glide of the sliding sashes.

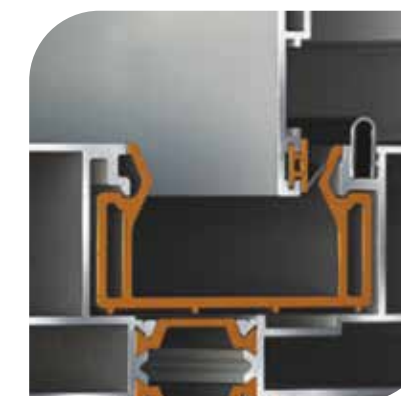

The unique **PVC** profiles contribute to excellent **thermal insulation**, water tightness, and UV protection. This ensures remarkable durability and texture retention even under intense exposure to solar radiation



Wide variety of infill thickness for double or triple glazing from **22 mm up to 45 mm.**



The system ensures an **exceptionally noiseless and flawless operation** of the sashes, effortlessly accommodating large and heavy constructions through the use of inox rails.

Locking system

SLIDING VERSION

High-security system thanks to multiple locking points and cylinder lock option.

LIFT & SLIDE VERSION

Ideal for heavy-duty constructions **up to 300 Kg** per sash cooperating with the Lift & Slide mechanism which offers:

- Outstandingly smooth and quiet movement of the sliding sashes.
- High anti-burglary protection, made possible by robust hardware components and concealed locking points.
- Effortless instead of easy operation even of large and heavy sashes.
- Enhanced safety with the cooperation of a silent close accessory, ensuring soft and secure closure of the sashes.



FOCUS

ON SAFETY

Handles

The system comes with exquisitely designed branded handles, crafted by world-class specialists in collaboration with ALUMIL, ensuring unparalleled quality and flawless performance. These handles, meticulously crafted from aluminium, offer a wide range of standard colours to choose from, allowing you to customise your system to perfection.



2 Sashes / 2 Track

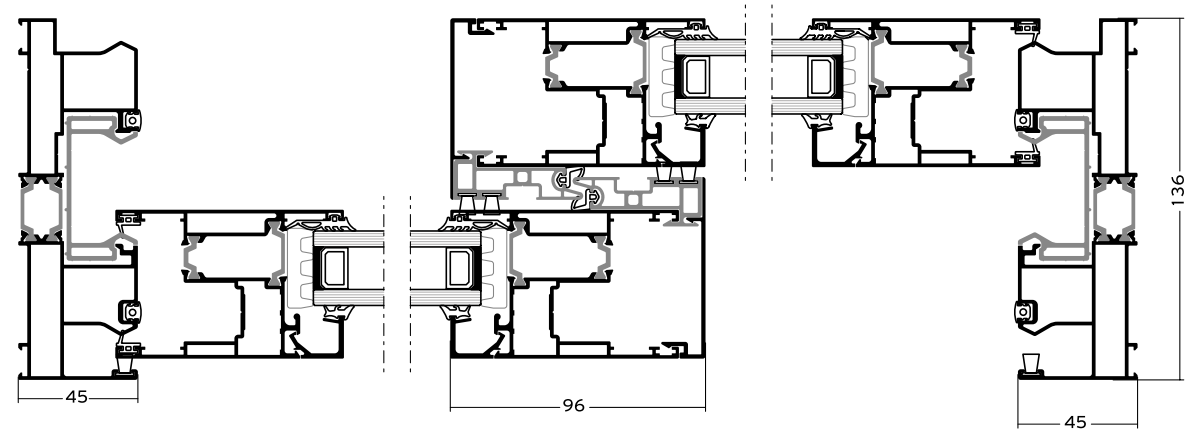
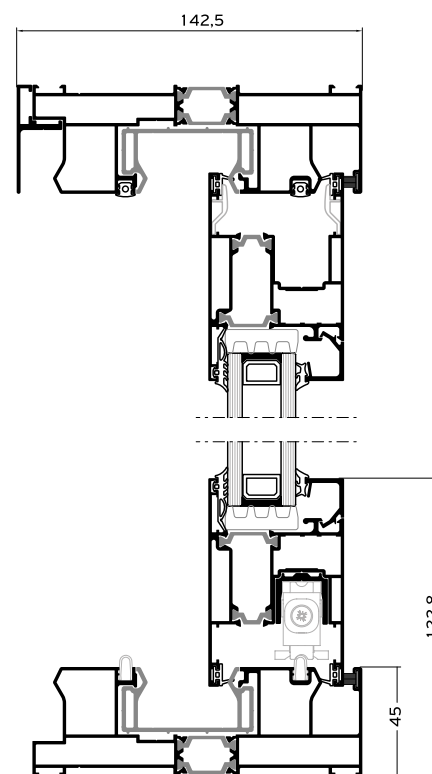
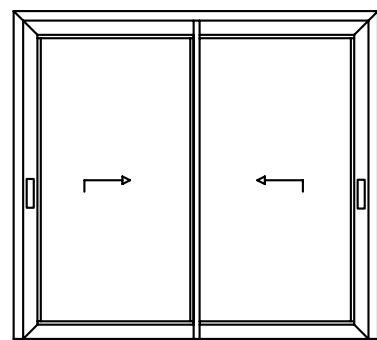

2 Sashes / 2 Track Low Threshold

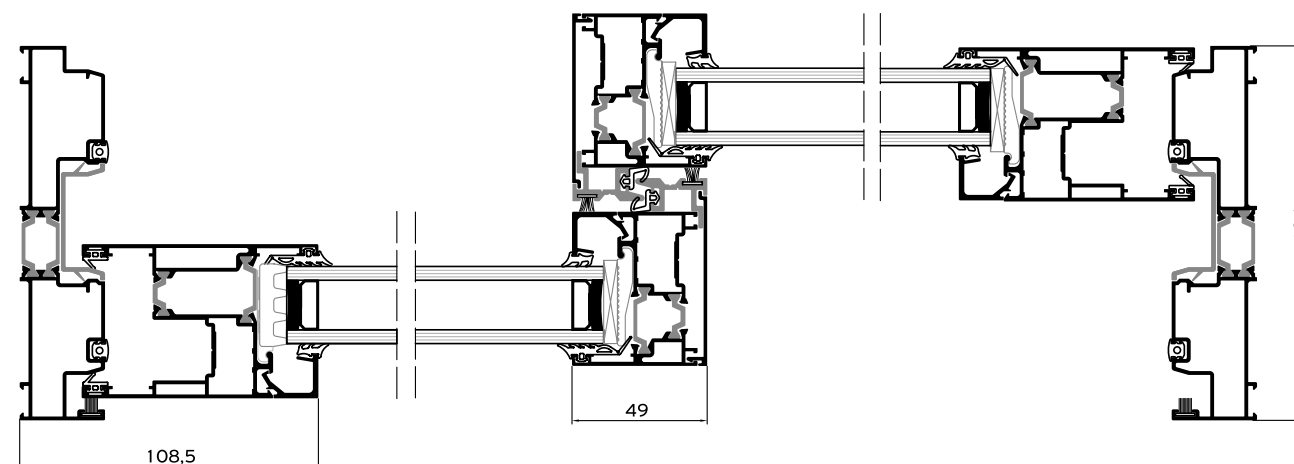
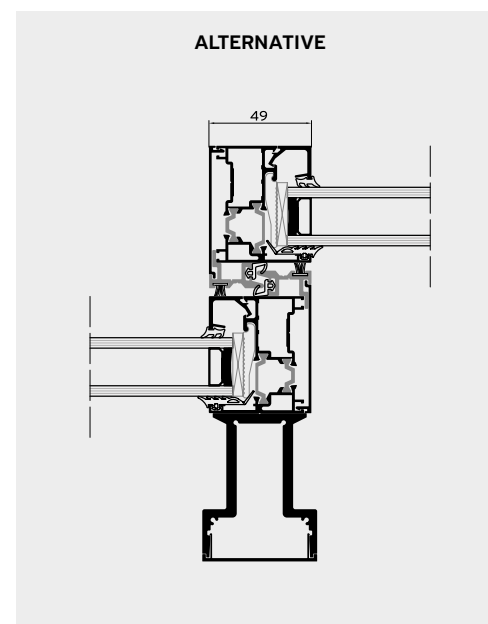
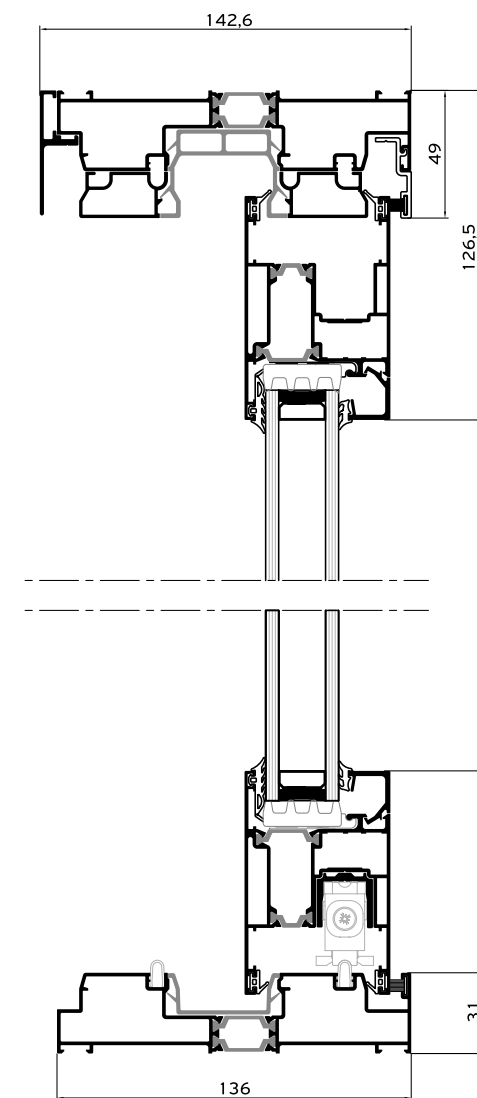
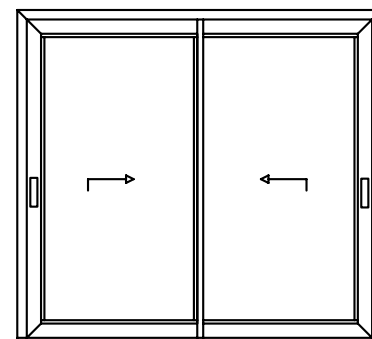

3 Sashes / 3 Track

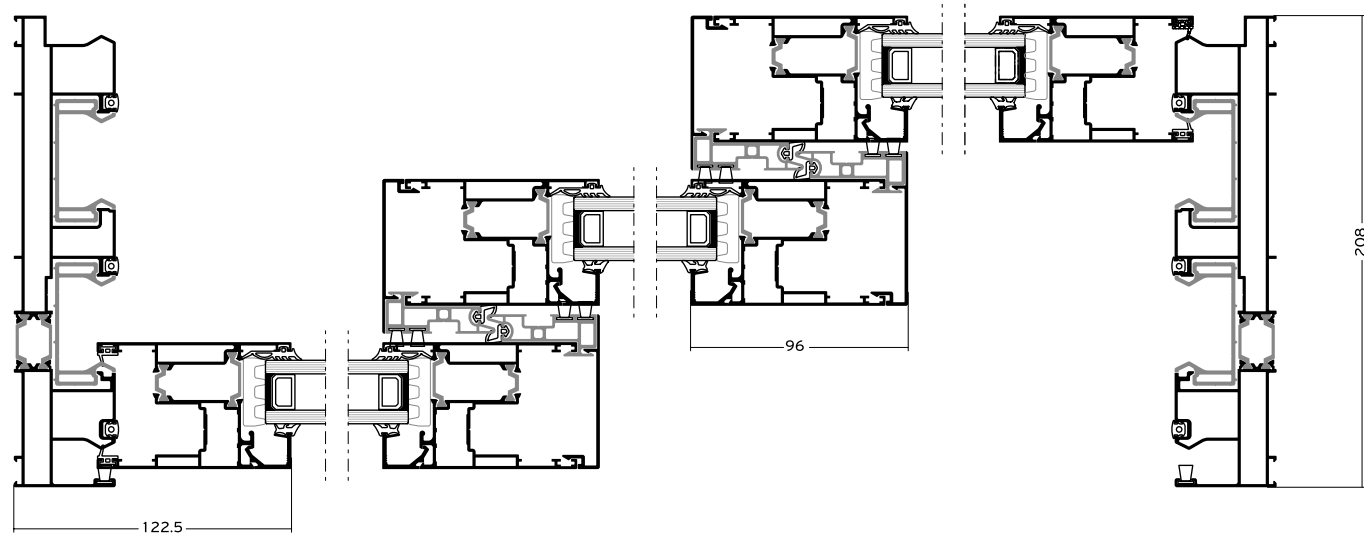
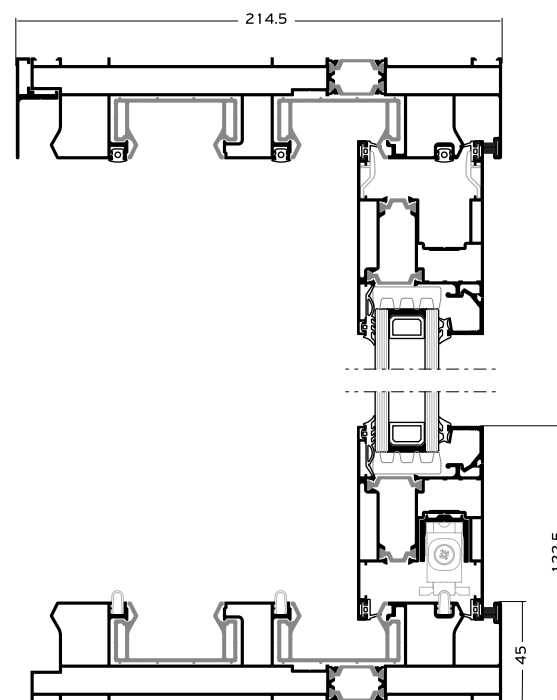
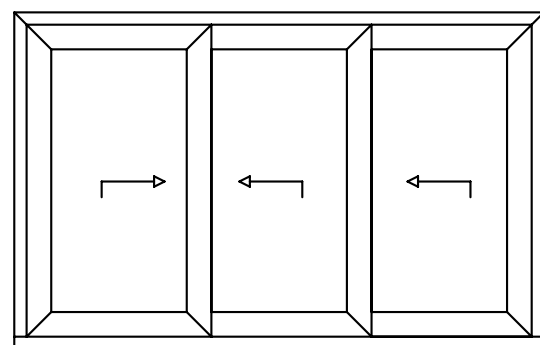

3 Sashes / 3 Track Low Threshold

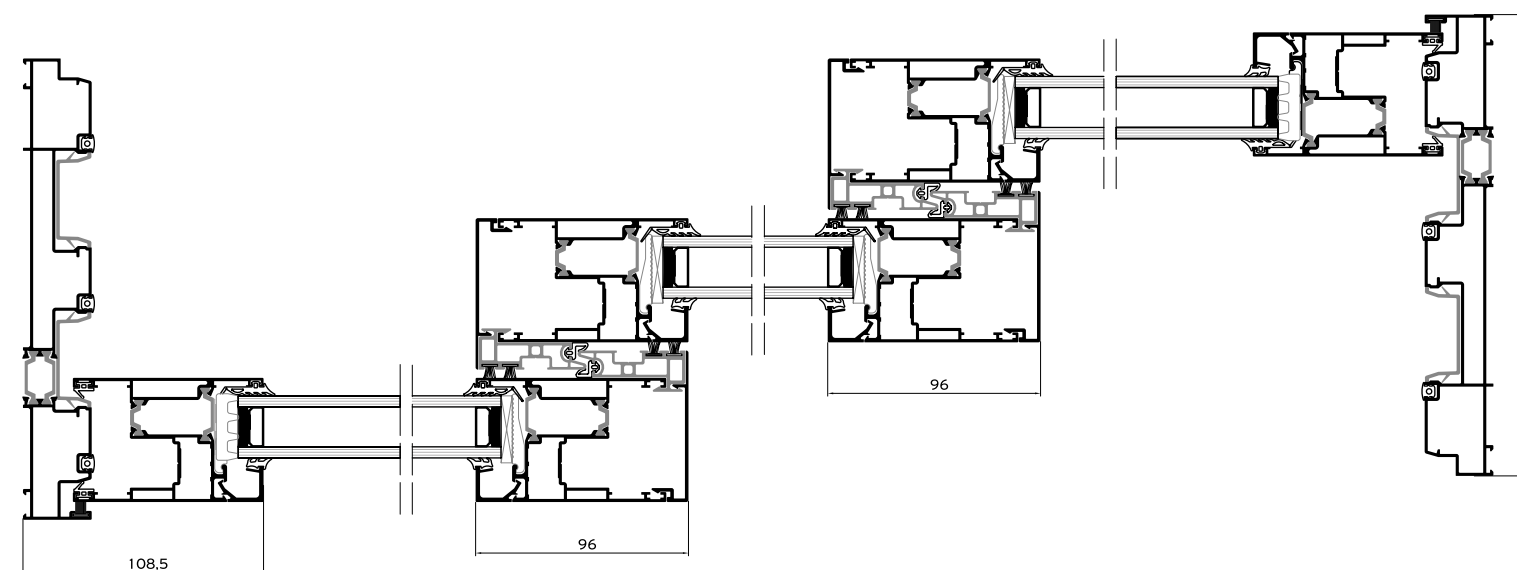
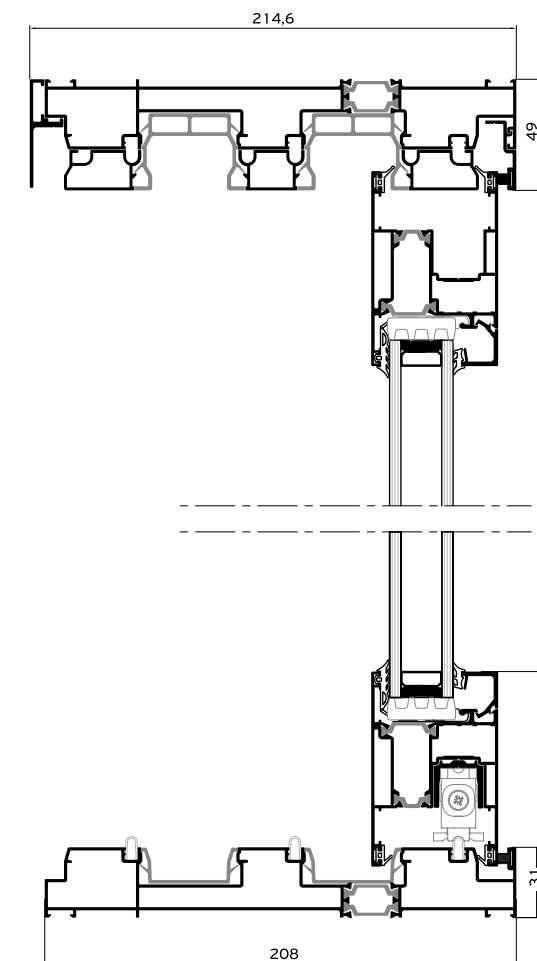
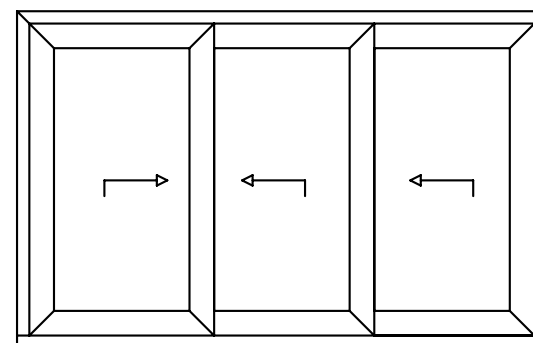

POCKET WINDOW
2 Sashes / 1 Track /
Flyscreen / Shutter

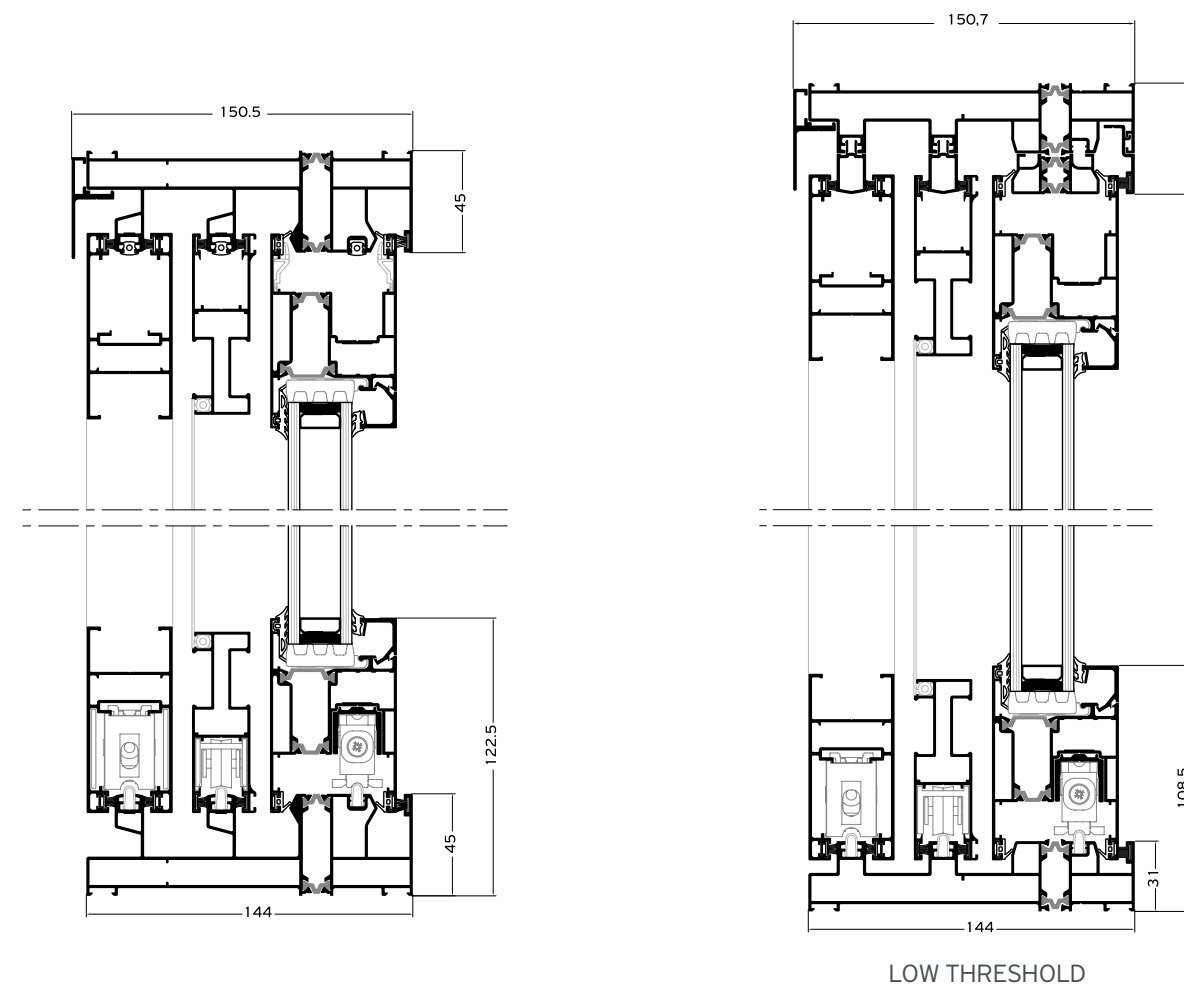
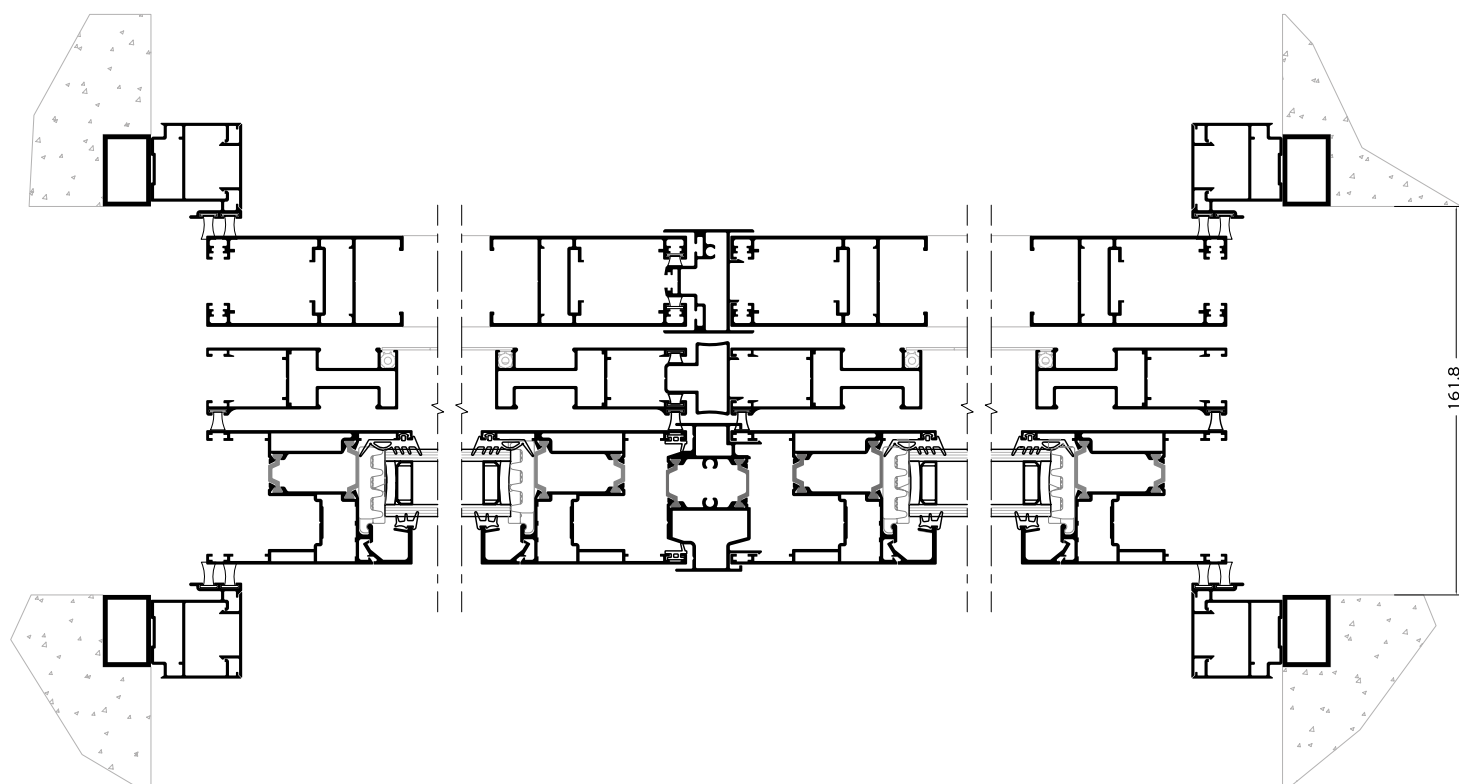
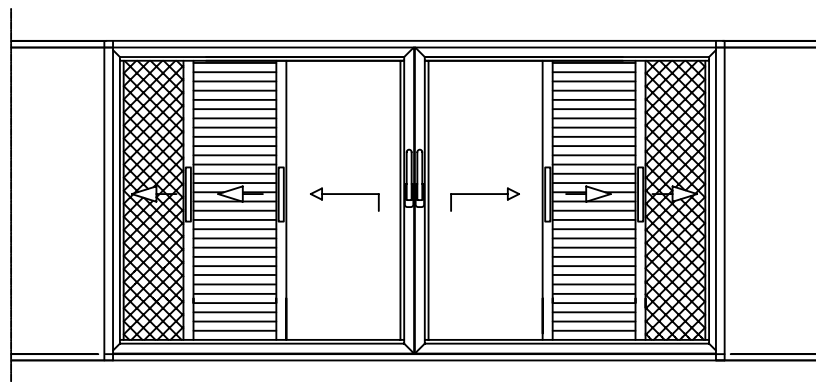

1 sash / Fixed light
Structural
*Custom made solution

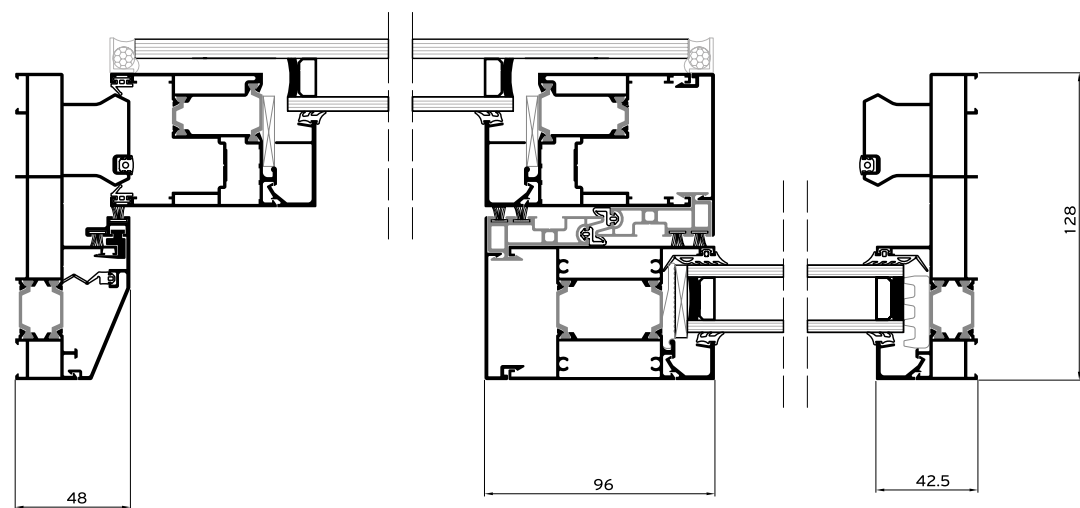
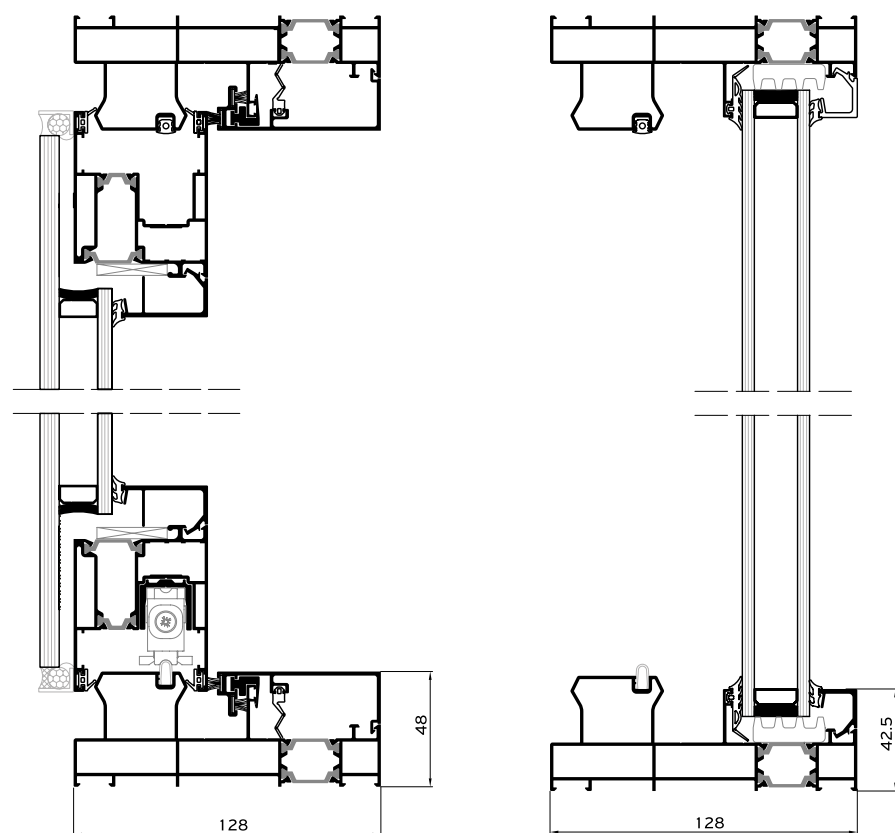
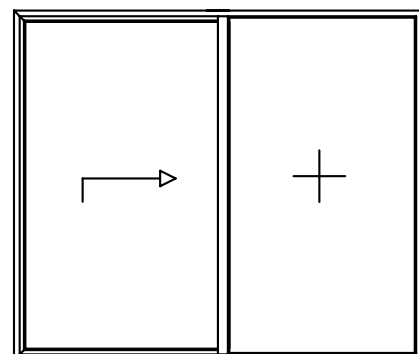

1 sash / Fixed light

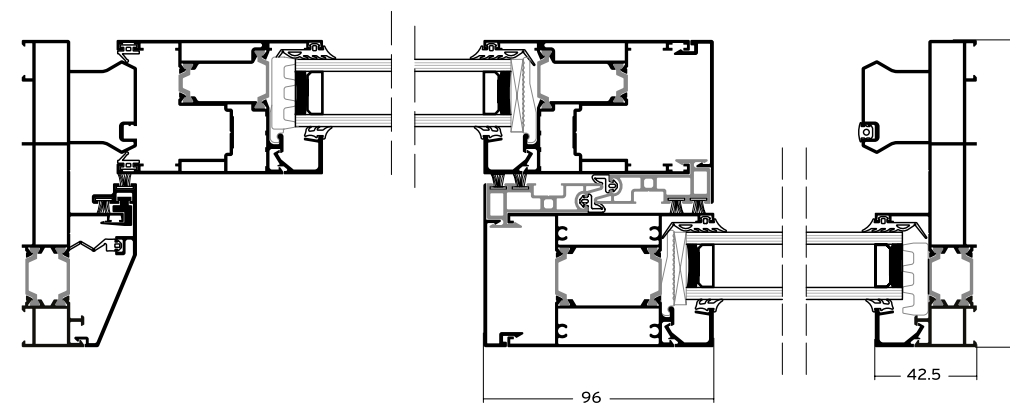
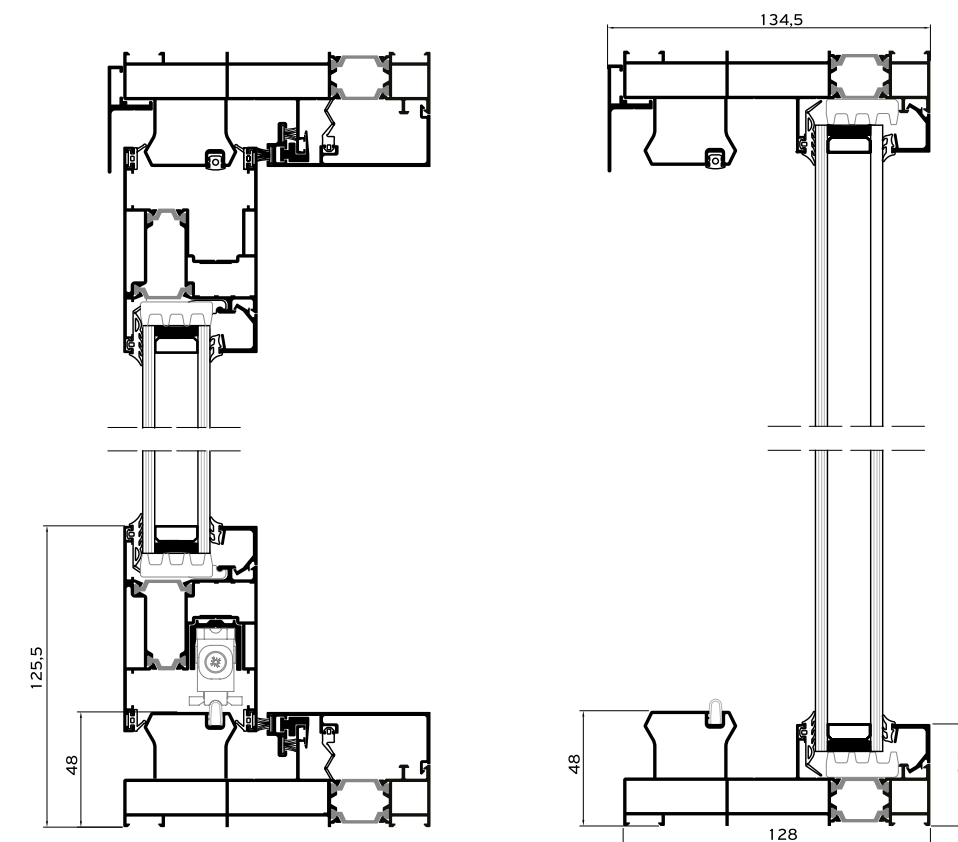
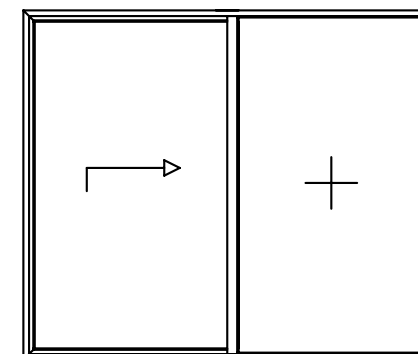

Alumil SMARTIA
S560

Fixed light / 1 sash / Fixed light

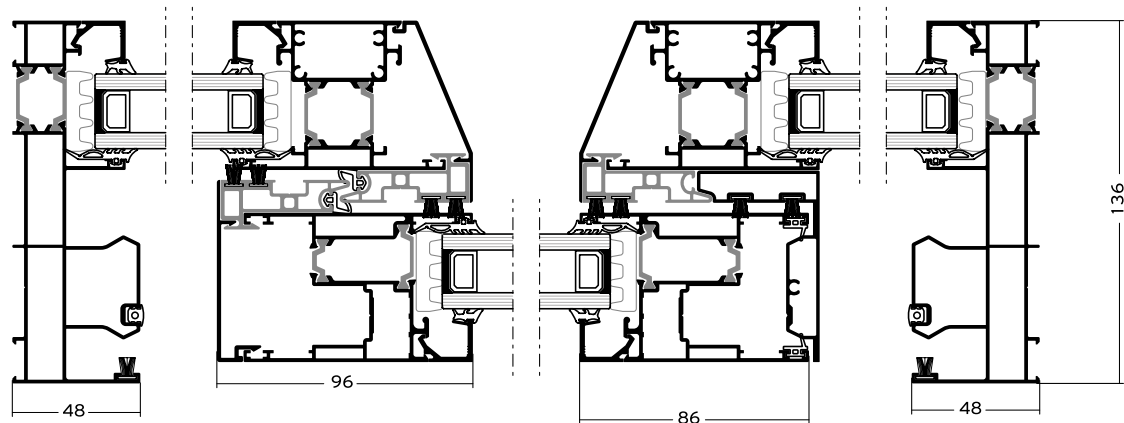
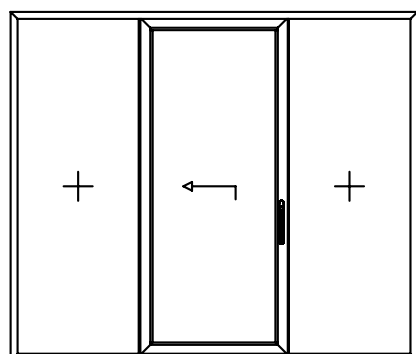

4 Sashes / 2 Track

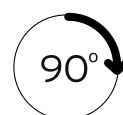
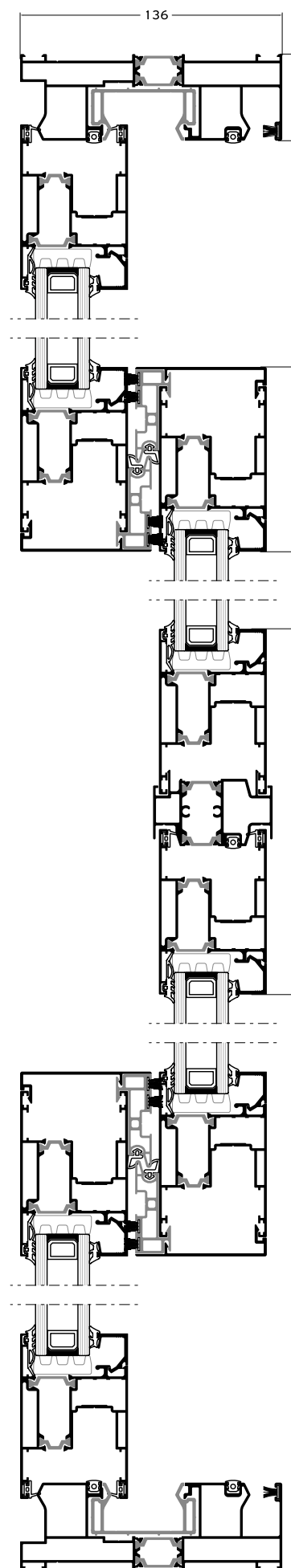
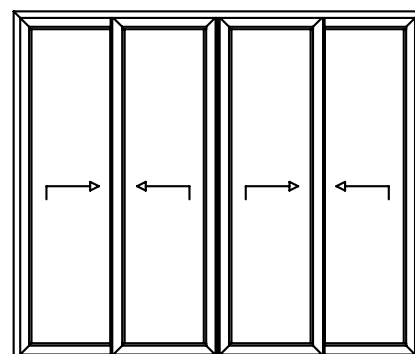

MULTI TRACK Low Threshold

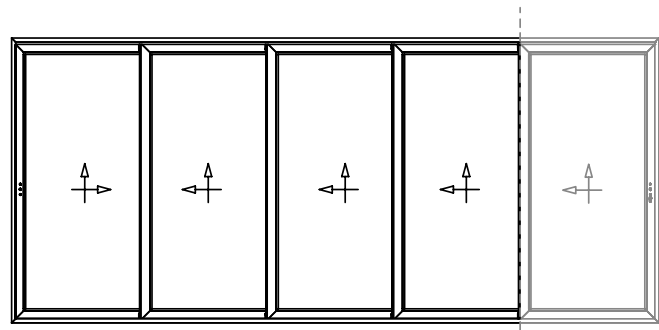

NO LIMITS AT THE NUMBER OF THE HORIZONTAL SASHERS
WITH THE MULTI-TRACK TYPOLOGIES

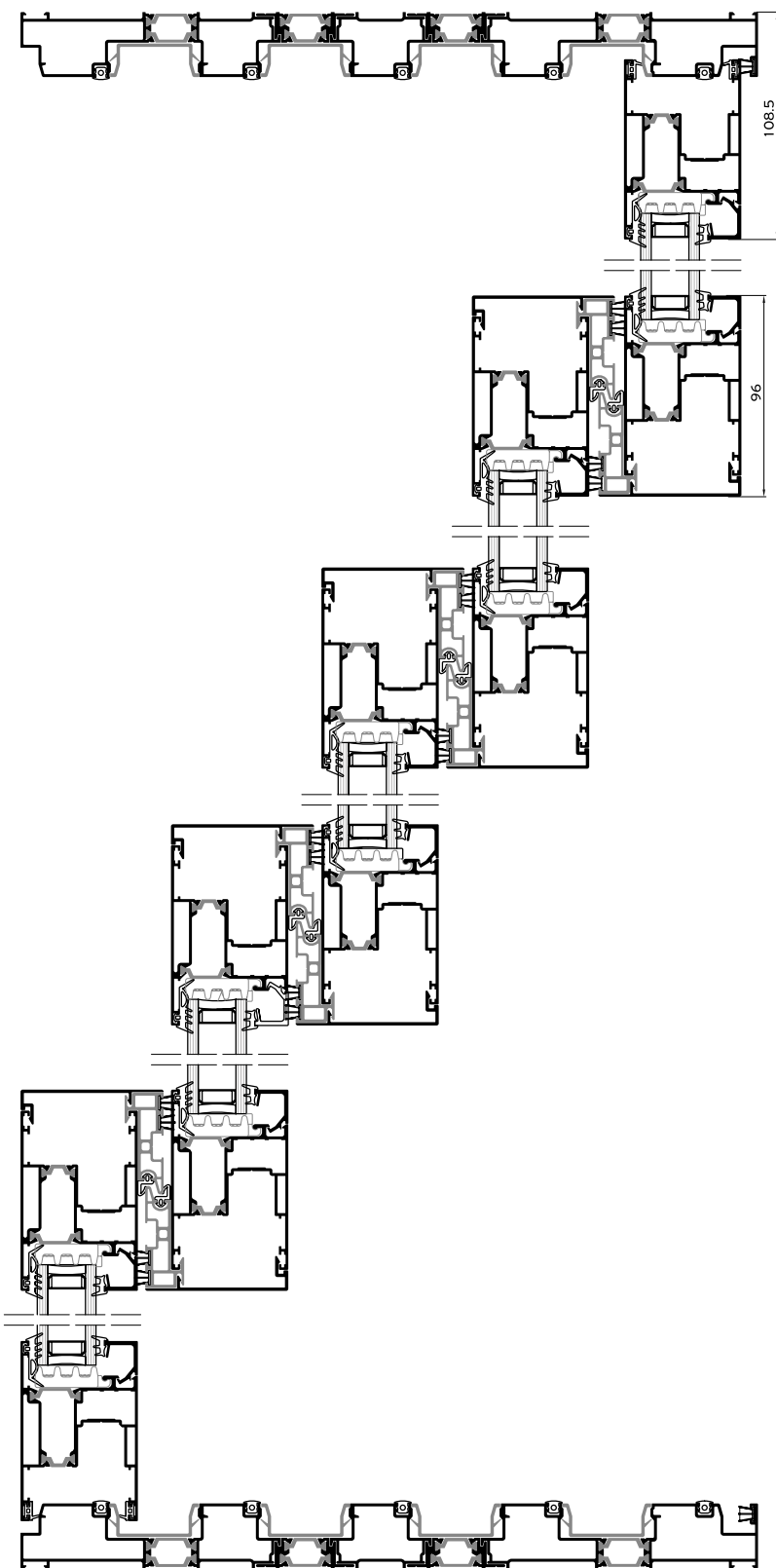

CORNER WINDOW External / Internal corner

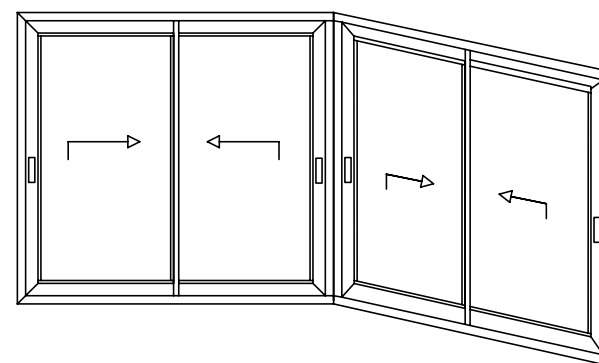

Applications

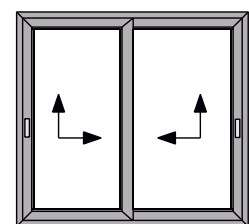

2 SASHES / 2 TRACK

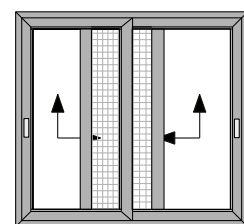

2 SASHES / 2 TRACK /
FLYSCREEN

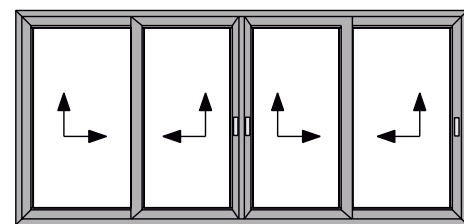

4 SASHES / 2 TRACK

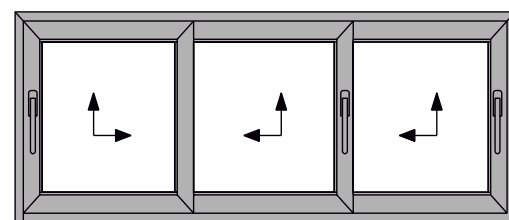

3 SASHES / 2 TRACK

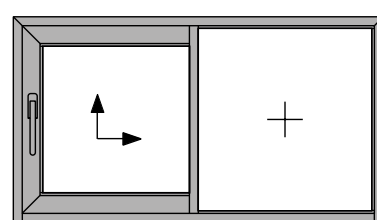

1 SASH / 1 FIXED

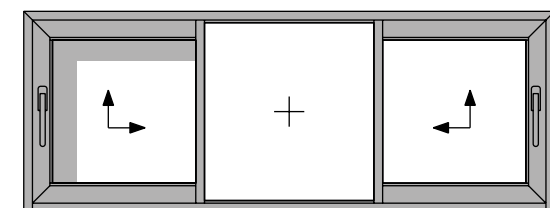

1 SASH / 1 FIXED / 1 SASH

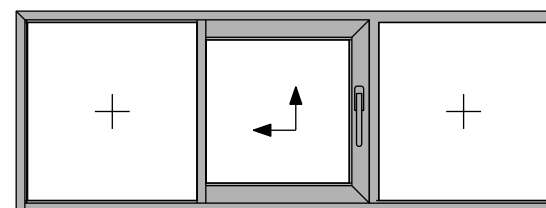

1 FIXED / 1 SASH / 1 FIXED

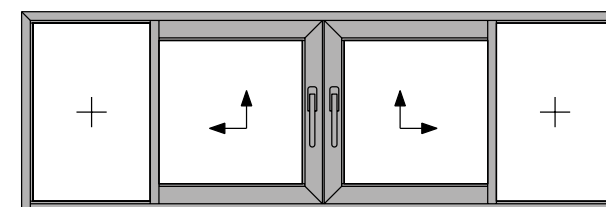

2 SASHES / 2 FIXED

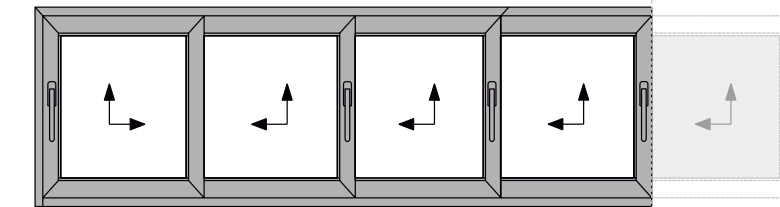

MULTI TRACK

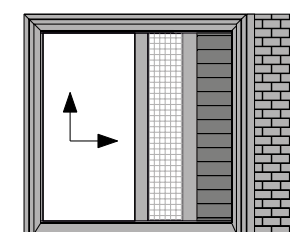

1 SASH / 1 TRACK /
FLYSCREEN / SHUTTER

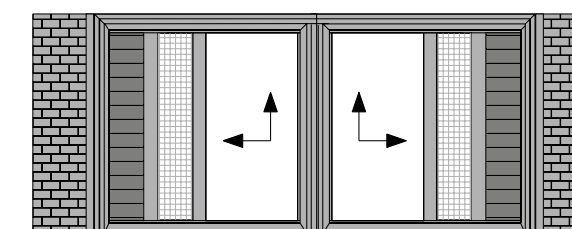

2 SASHES / 1 TRACK / FLYSCREEN / SHUTTER

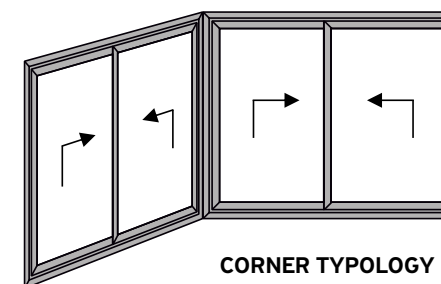

CORNER TYPOLOGY

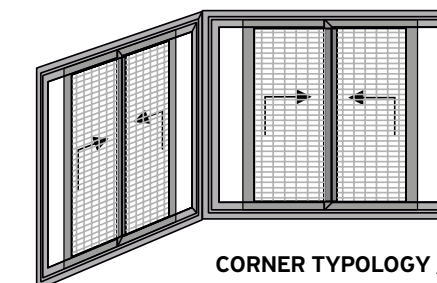







CORNER TYPOLOGY /
FLYSCREEN

- ALL TYPOLOGIES ARE AVAILABLE FOR BOTH LIFT & SLIDE AND SLIDING CONFIGURATIONS.
- AVAILABILITY OF LOW THRESHOLD FOR ALL TYPOLOGIES.

Table of performance

SMARTIA S560





CERTIFICATION	CLASSIFICATION									
 WATER TIGHTNESS EN 12208	1A (0 Pa)	2A (50 Pa)	3A (100 Pa)	4A (150 Pa)	5A (200 Pa)	6A (250 Pa)	7A (300 Pa)	8A (450 Pa)	9A (600 Pa)	E1200 (1200 Pa)
 AIR PERMEABILITY EN 12207	1		2			3		4		
 WIND LOAD RESISTANCE MAX TEST PRESSURE EN 12210	1 (400 Pa)		2 (800 Pa)		3 (1200 Pa)		4 (1600 Pa)		5 (2000 Pa)	
 WIND LOAD RESISTANCE TO FRONTAL DEFLECTION EN 12210	A (≤ 1/150)			B (≤ 1/200)			C (≤ 1/300)			
 BURGLAR RESISTANCE EN 1627 -1630	RC 1			RC 2				RC 3		
 SOUND REDUCTION EN14351	38 dB									

CERTIFICATIONS ACCORDING TO AS STANDARDS AND AAMA STANDARDS ARE AVAILABLE FROM ALUMIL UPON REQUEST



The OK Recycled certification by TÜV AUSTRIA attests that all our profiles are made of 60% recycled aluminium, contributing to a more sustainable future.

SMARTIA S560 LT

CERTIFICATION	CLASSIFICATION								
 WATER TIGHTNESS EN 12208	1A (0 Pa)	2A (50 Pa)	3A (100 Pa)	4A (150 Pa)	5A (200 Pa)	6A (250 Pa)	7A (300 Pa)	8A (450 Pa)	9A (600 Pa)
 AIR PERMEABILITY EN 12207	1		2			3		4	
 WIND LOAD RESISTANCE MAX TEST PRESSURE EN 12210	1 (400 Pa)		2 (800 Pa)		3 (1200 Pa)		4 (1600 Pa)		5 (2000 Pa)
 WIND LOAD RESISTANCE TO FRONTAL DEFLECTION EN 12210	A (≤ 1/150)			B (≤ 1/200)			C (≤ 1/300)		

THERMAL PERFORMANCE	DIMENSIONS IN MM (W x H)	U _w in W/m ² K (U _g = 0,6)	U _w in W/m ² K (U _g = 0,8)	U _w in W/m ² K (U _g = 1,1)
1 SASH / FIXED LIGHT	2300 x 2180	1,32	1,48	1,72
2 SASHES / 2 TRACK	2300 x 2180	1,45	1,60	1,84
2 SASHES / 2 TRACK LOW THRESHOLD	2300 x 2180	1,46	1,62	1,85
4 SASHES / 2 TRACK	4600x2180	1,38	1,53	1,76
4 SASHES / 2 TRACK LOW THRESHOLD	4600x2180	1,29	1,45	1,68

REFERENCE PROJECTS

- 1. MIRAGGIO THERMAL SPA RESORT / HALKIDIKI, GREECE
- 2. CENTURY PLAZA HOTEL / LOS ANGELES, U.S.A.
- 3. AMARA HOTEL / LIMASSOL, CYPRUS
- 4. U HOUSE / ULA, TURKEY
- 5. REGNUM SKY TOWER / ANKARA, TURKEY
- 6. CARAVIA BEACH HOTEL / KOS, GREECE



1



2



3



4



5



6



REFERENCE PROJECTS

- 7. ARMA KULE / ANKARA, TURKEY
- 8. METSAN NEXUS / ISTANBUL, TURKEY
- 9. NATIONAL GALLERY / ATHENS, GREECE

- 10. Z HOUSE / KERKYRA, GREECE
- 11. COCO-MAT ATHENS BC HOTEL / ATHENS, GREECE
- 12. AMERICAN FARM SCHOOL / THESSALONIKI, GREECE



7

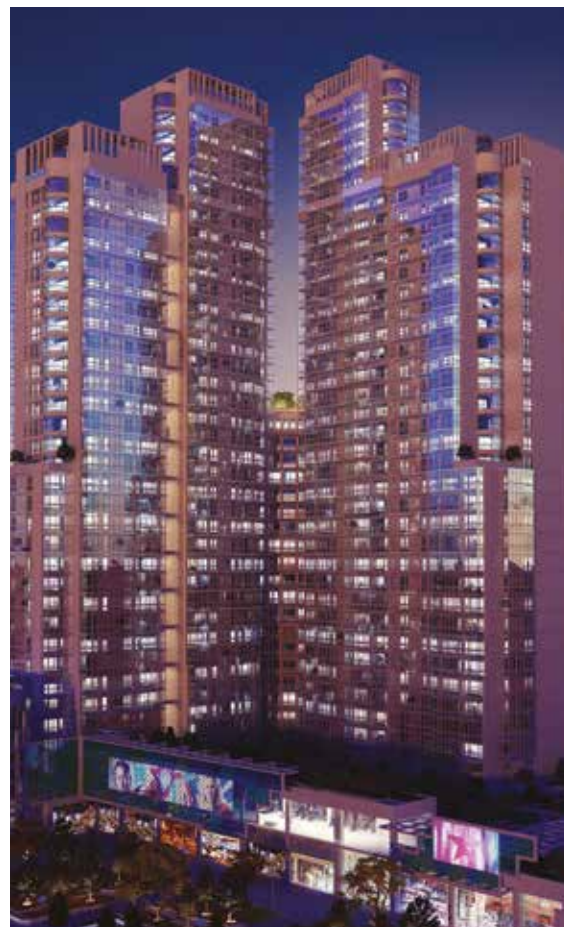

8



9



10



11



12

REFERENCE PROJECTS

13. HUG HOUSE / KOS, GREECE

14. OXYGEN / ATHENS, GREECE

15. GREEN COAST RESORT & RESIDENCES / PALASA, ALBANIA

16. NICHE HOTEL / ATHENS, GREECE

17. EMERALD TERRACES / ATHENS, GREECE

18. VILLA AGAPANTHUS / LEFKADA, GREECE



13



16



17



14



15



18

www.alumil.com

DISCOVER MORE:



**ALUMIL
HEAD OFFICES
& SHOWROOM - THESSALONIKI**

GOGOUSI 8, EFKARPIA
THESSALONIKI - GR 56429
TEL.: +30 2313011000
E-MAIL.: info@alumil.com

**ALUMIL
HEADQUARTERS**

KILKIS INDUSTRIAL AREA
KILKIS - GR 61100
TEL.: +30 23410 79300
E-MAIL.: info@alumil.com



**ALUMIL
HEAD OFFICES
& SHOWROOM - THESSALONIKI**

GOGOUSI 8, EFKARPIA
THESSALONIKI - GR 56429

TEL.: +30 2313 011000
EMAIL: INFO@ALUMIL.COM

**ALUMIL
HEADQUARTERS**

KILKIS INDUSTRIAL AREA
KILKIS - GR 61100

TEL.: +30 23410 79300
E-MAIL: info@alumil.com

www.alumil.com

alumil