

The Alumil logo is positioned on a yellow diagonal band. It features the word "Alumil" in a bold, dark grey sans-serif font. The letter "A" is stylized with a diagonal slash through it. A small white square is placed above the letter "i".

Alumil

The Alumil SMARTIA M7 logo is located in the bottom left corner. It consists of the word "Alumil" in a bold, dark grey sans-serif font, followed by a yellow chevron symbol pointing to the right. To the right of the chevron is the word "SMARTIA" in a dark grey sans-serif font, and below it is the text "M7" in a smaller dark grey sans-serif font.

Alumil  SMARTIA
M7

Contents

*“To see beauty
is to see light”*

Victor Hugo

Upgrading the experience of transparent architecture

Smartia M7 is a, value for money, complete curtain wall system with high energy efficiency, which offers wide range of options in terms of aesthetics and contemporary architecture.

- / Available in various design like standard pressure plates, structural glazing and linear solutions.
- / Interior/exterior visible width: 50mm.
- / Wide range of mullion and transom depths.
- / All kinds of opening types can be seamlessly integrated such as top hung window, parallel opening window, tilt and turn window, concealed vent window, entrance door.
- / Attention in specified solutions concerning heavy glass panes up to 700kg.
- / Certified with the highest level of antiburglar resistance (RC4).
- / High energy efficiency (U_f from 1 up to 2,3 W/m²K).

 SMARTIA
M7

SYSTEM CAPABILITIES	04
TECHNICAL CHARACTERISTICS	06
VARIETY OF SOLUTIONS	08
POINTS OF EXCELLENCE	10
SECTIONS	12
APPLICATIONS/CONFIGURATIONS	19
HANDLES	20
TABLE OF PERFORMANCE	21
REFERENCE PROJECT	22



System capabilities

STANDARD

Glazing infill (4-54) mm

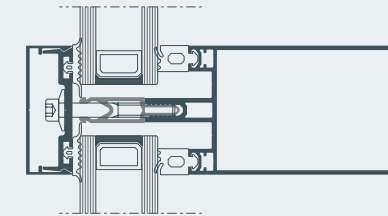

STRUCTURAL

Glazing infill (32-38) mm

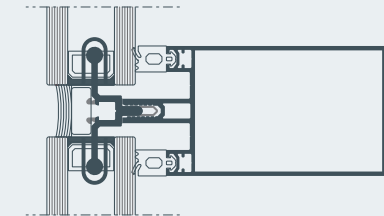

HORIZONTAL LINEAR

Glazing infill (4-28) mm

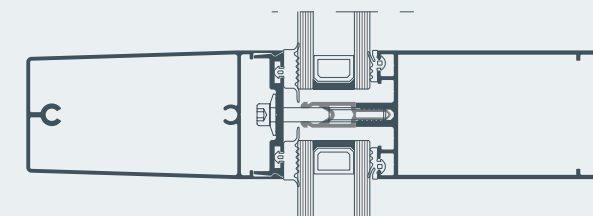
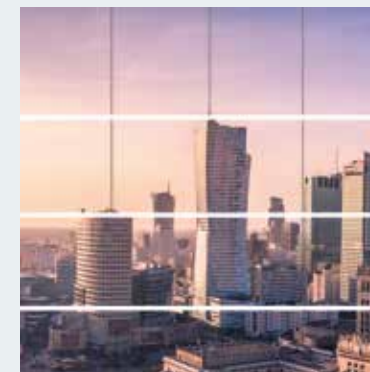

VERTICAL LINEAR

Glazing infill (4-28) mm

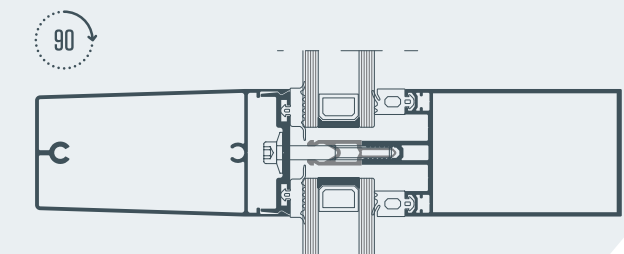

Technical characteristics



- / 50mm visible width of mullions and transoms.
- / High thermal insulation up to $U_f=1 \text{ W/m}^2\text{K}$.
- / Options of linear (horizontally or vertical) and structural constructions using the same mullions and transoms.
- / Wide range of mullions and transoms depths:
28-266 mm for mullions
16,5-266 mm for transoms
- / Glass thickness 4-54 mm.
- / Special isolators and EPDM gaskets for maximum thermal and sound insulation.
- / Incorporates ALUMIL M5600 solar shading system.
- / Compatible with all Alumil opening systems (top hung window, parallel opening window, tilt and turn window, concealed vent window) as well as Alumil entrance doors.





Aesthetics

Smartia M7 is a curtain wall system that offers unlimited design freedom by using different types of external caps. The 4 different types of glazing variant (standard pressure plate, linear horizontal and vertical, structural) combined with variety of infills (glass, insulating panels) can meet all contemporary architectural needs.

Typologies

Smartia M7 is fully adjustable with all types of openings such as top hung window, parallel opening, tilt and turn, concealed vent and all types of entrance doors.

Construction

Wide range of mullions able to meet with the most demanding building standards. Steel reinforcements can be integrated into mullions to achieve maximum static sufficiency.

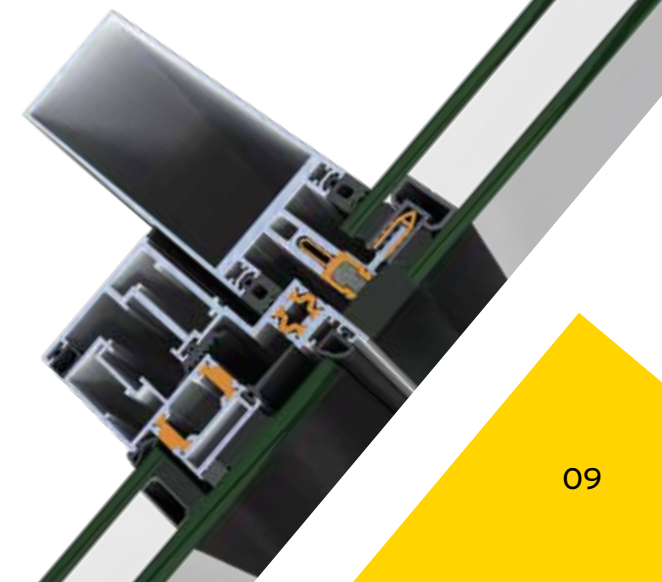

Points of excellence



SMARTIA M7 is a curtain wall system that can offer innovative solutions in terms of big, heavy and high insulated glazing panes. M7 supports glazing panes up to 700 kg with the use of special profiles.

In this way, M7 offers the freedom to go beyond to normal matrix grid and minimize visible aluminium.

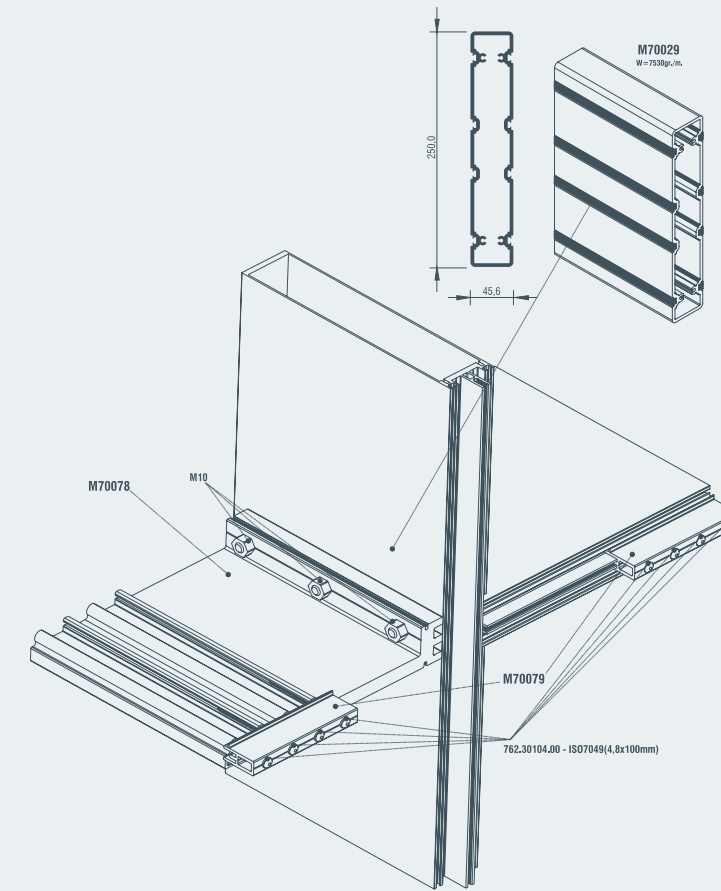

SMARTIA M7 is a fully certified system in terms of thermal insulation, acoustic performance, air/water tightness, and wind load resistance.

Furthermore, SMARTIA M7 is certified in RC4 concerning Burglar Resistance that makes it an ideal system for big scale projects with high standards of safety.



Smartia M7 is a curtain wall system that offers innovative solution in terms of concealed opening vents.

With the use of split mullions we can preserve the external appearance of façade by integrating frame profile into split mullions.

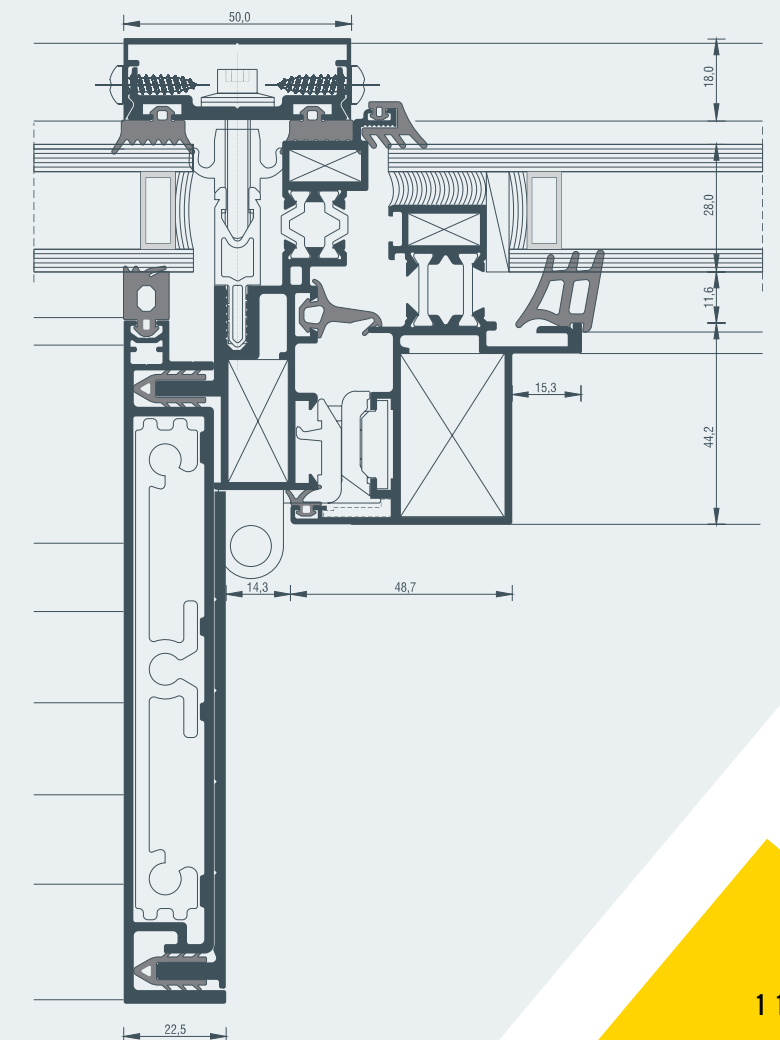
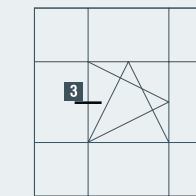

Standard mullion

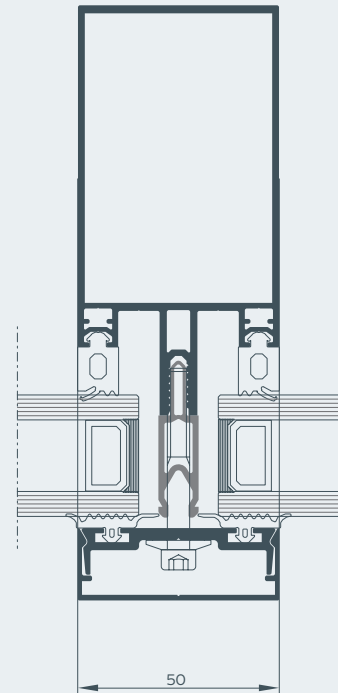

Standard projected window

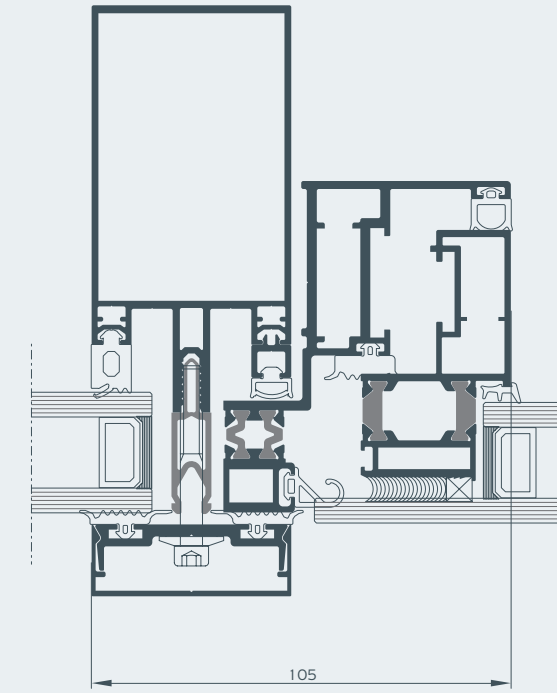

Standard transom

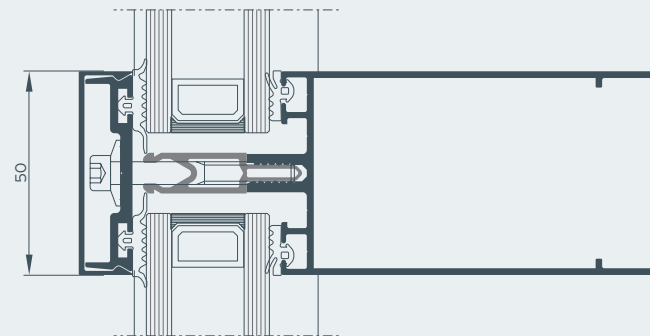

Standard projected parallel window

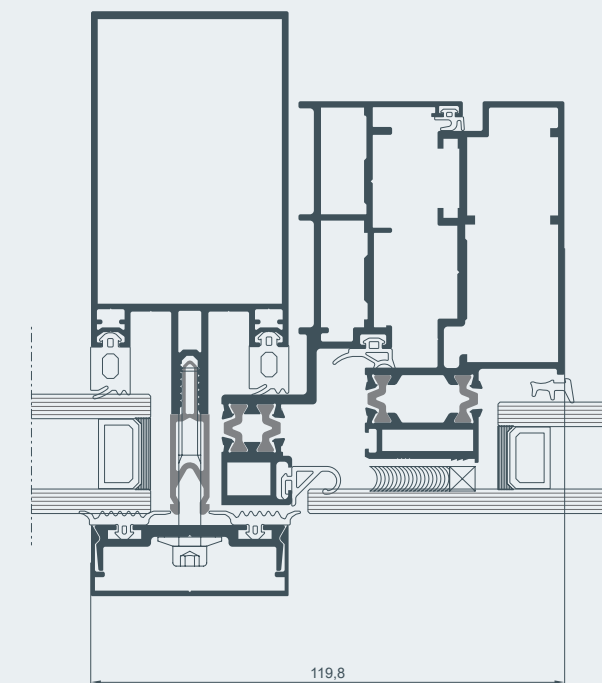

Standard tilt and turn window

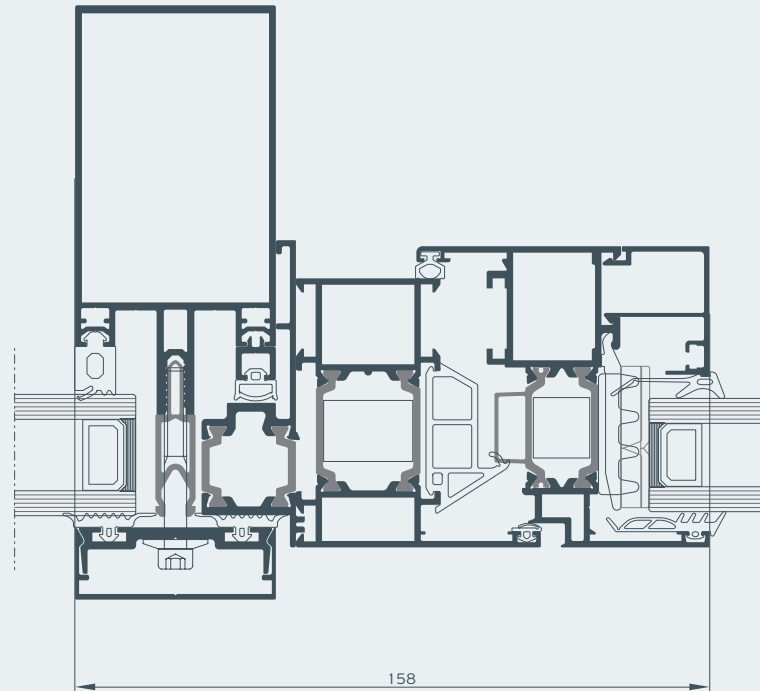

Structural mullion

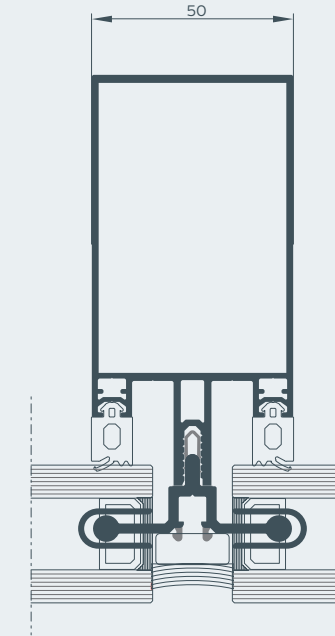

Standard concealed window

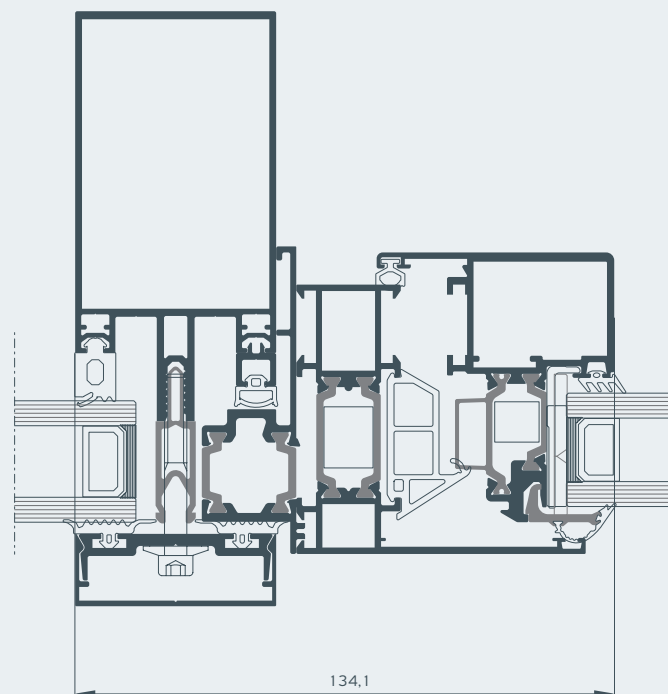

Structural transom

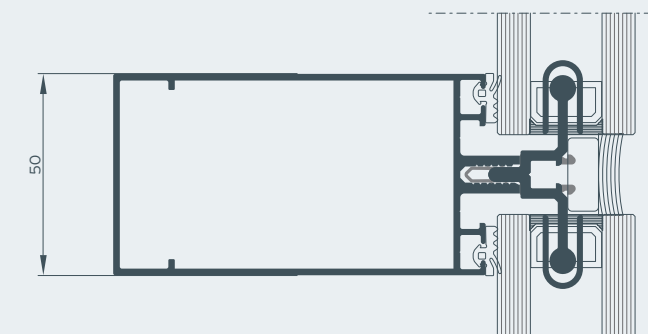

Structural projected window

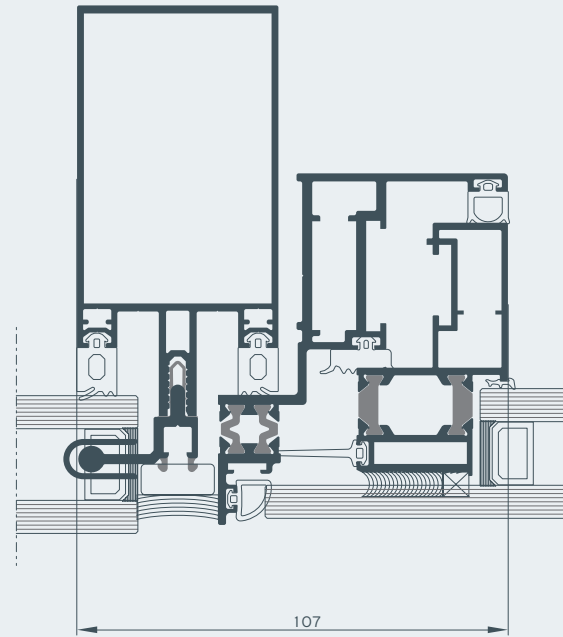

Structural tilt and turn window

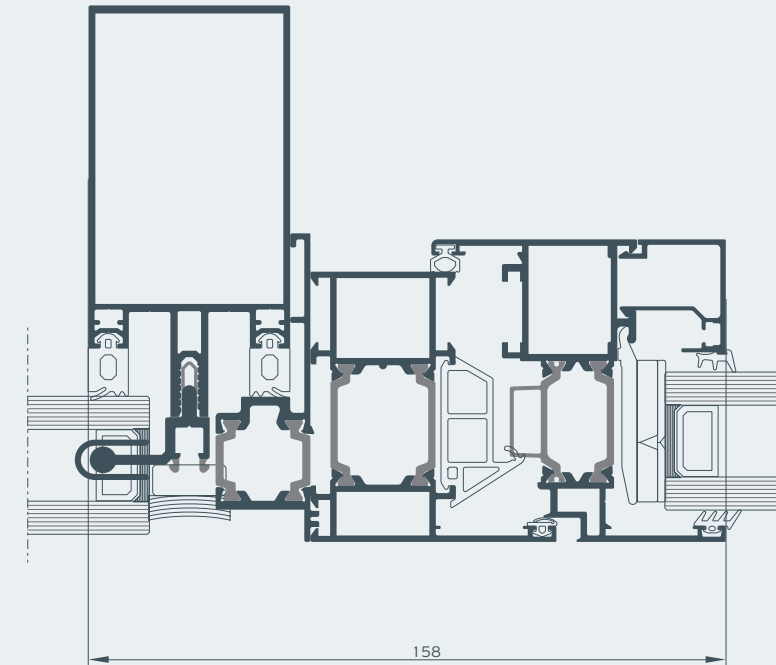

Structural projected parallel window

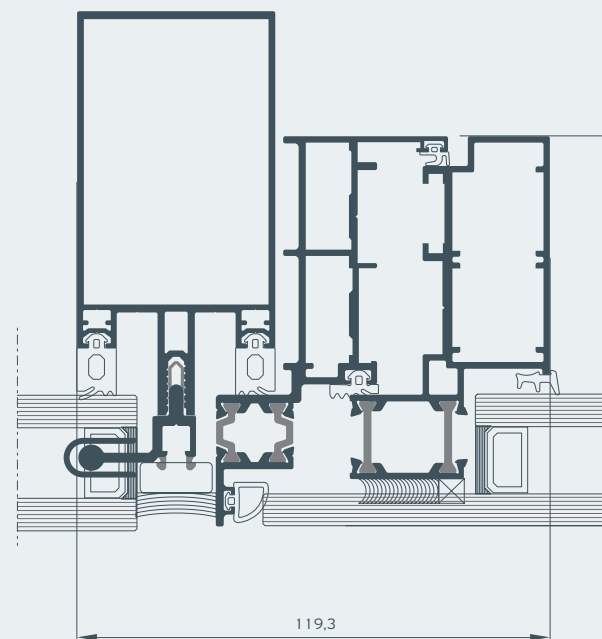

Structural projected parallel window

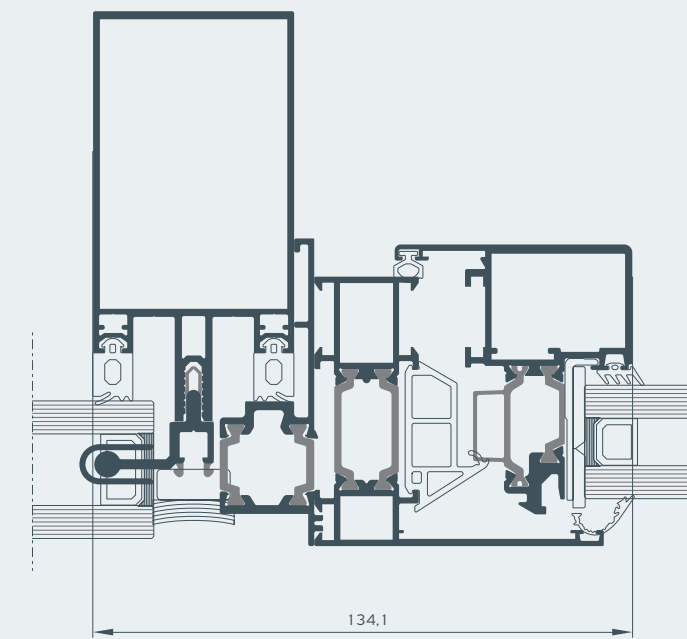

Standard entrance door

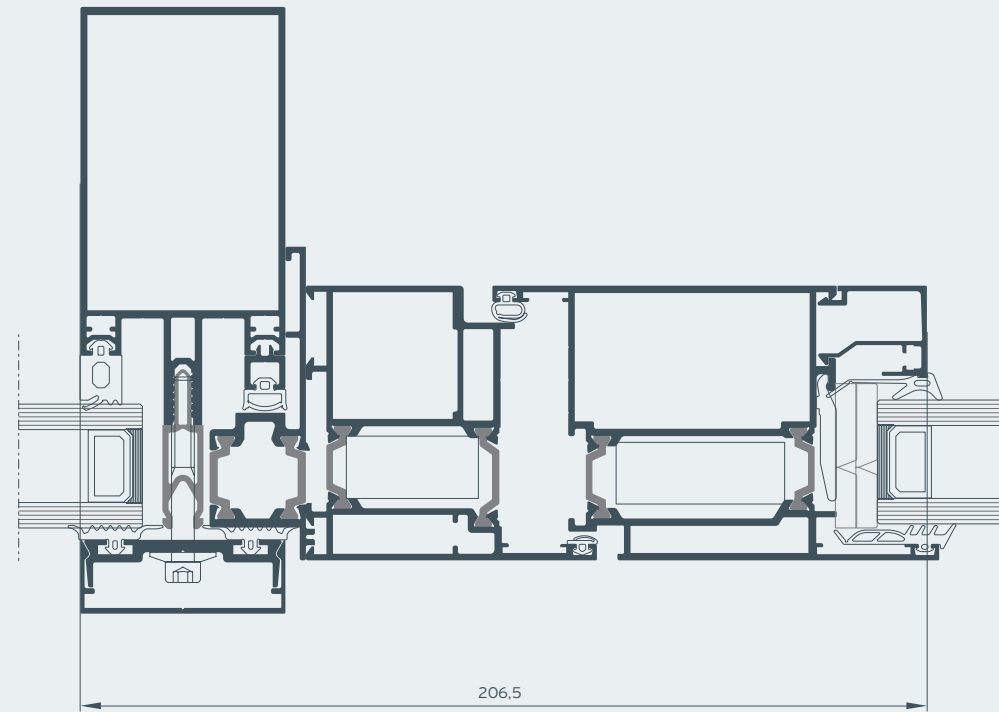

Structural entrance door

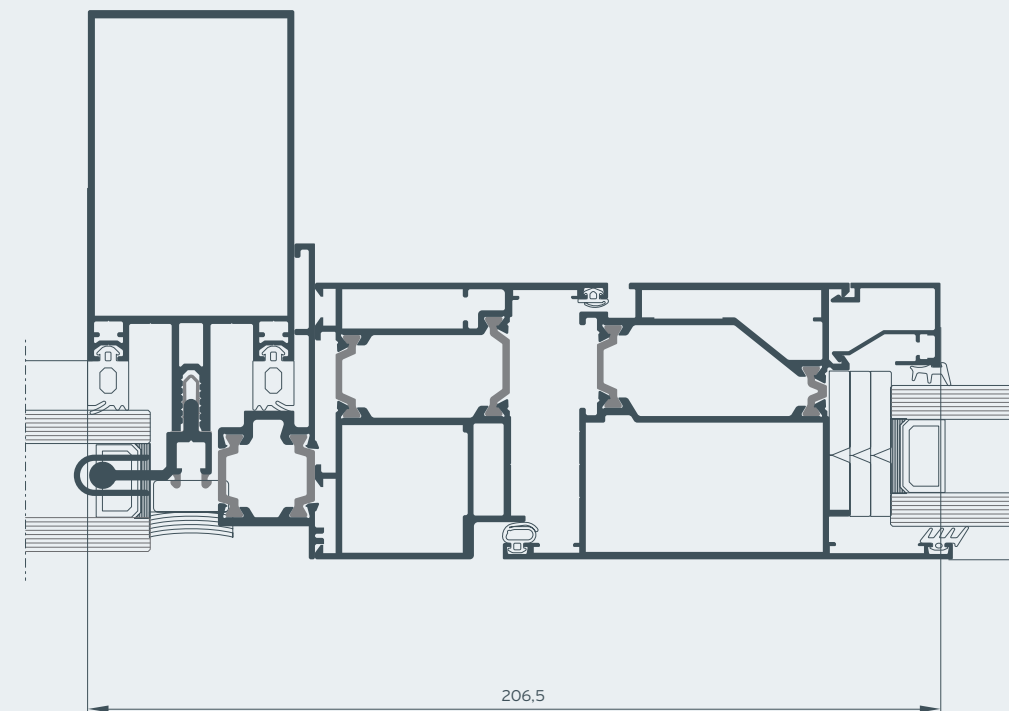

Applications

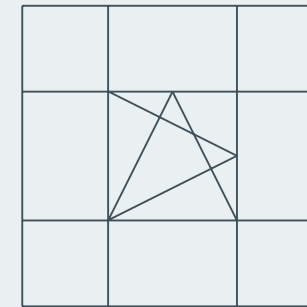

Tilt and turn vent window
Tilt and turn vent conceal window

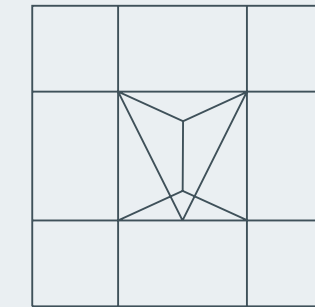

Parallel and projected
outward window

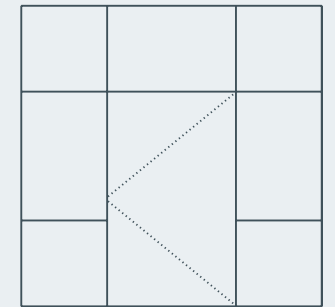

Hinged opening outward door

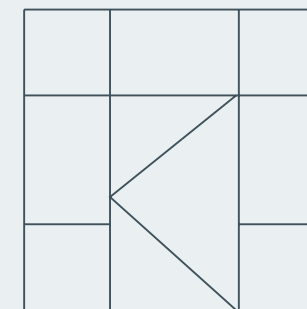

Hinged opening inward door

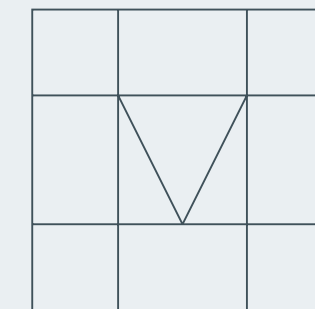



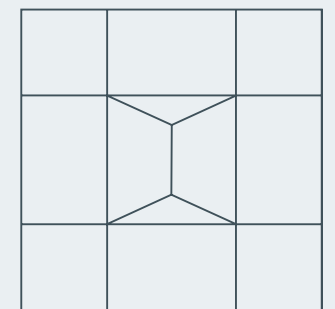

Projected outward window



Parallel projected
outward window



Table of performance

CERTIFICATION	CLASSIFICATION				
 Water tightness EN 12154	R4 (150 Pa)	R5 (300 Pa)	R6 (450 Pa)	R7 (600 Pa)	RE1200 (1200 Pa)
 Air permeability EN 12152	A1 (150 Pa)	A2 (300 Pa)	A3 (450 Pa)	A4 (600 Pa)	AE (>600 Pa)
 Wind load resistance, max. test pressure EN 13116	DESIGN LOAD ±2000 Pa		SAFETY LOAD ±2000 Pa		
 Burglar Resistance EN 1627 -1630	RC 2		RC 3	RC 4	
 Thermal insulation EN12631	U _i down to 1 W/m ² K depending on the profile combinations and glazing thickness				

ALUMIL branded handles are manufactured by world-class specialists to ensure top quality and flawless operation. Standard series made of aluminium are available in various standard colors.

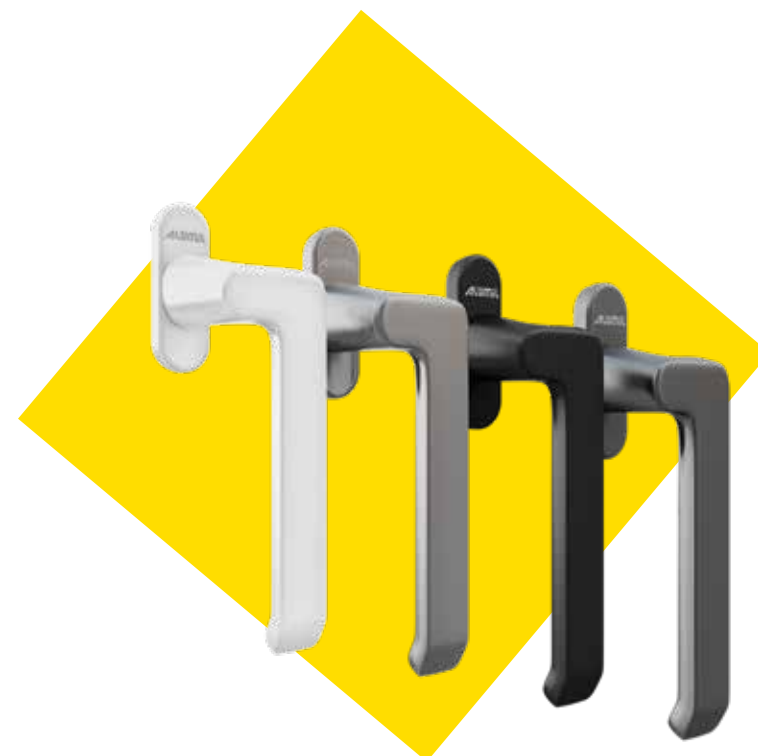



Green Plaza Athens, Greece



Miraggio Thermal Spa Resort
Halkidiki, Greece



Astana Congress Center Kazakhstan



Al Reem Tower Abu Dhabi, UAE



Nana Princess Hotel
Chersonissos, Crete



Al Jawhara Tower Jeddah, Saudi Arabia

Reference Projects



Sky Tower Ankara, Turkey

**ALUMIL
HEAD OFFICES
& SHOWROOM - THESSALONIKI**

Goçousi 8, Efkarpia
Thessaloniki - GR 56429
Tel.: +30 2313 011000
Fax: +30 2310 692473
E-mail: info@alumil.com

**ALUMIL
HEADQUARTERS**

Kilkis Industrial Area
Kilkis - GR 61100
Tel.: +30 23410 79300
Fax: +30 23410 71988
Email: info@alumil.com

