



Alumil

Alumil  SMARTIA
S67 URBAN



When outstanding performance of aluminium meets Art Déco aesthetics

SMARTIA S67 URBAN is a new hinged system that enriches ALUMIL's range with an option that successfully blends the present with the past and the classic with the modern.

Its unique aesthetics can easily meet the modern architecture trend of industrial design accompanied with all the top performances of a hinged insulated system.

Its aesthetics and technical features render S67 URBAN an ideal option for projects that industrial design is specified, whether they concern new buildings or upgrade of old steel framed windows.

SMARTIA S67 URBAN

SYNOPSIS OF CHARACTERISTICS	04
UNIQUE AESTHETICS	06
INSULATION AND SEALING TECHNOLOGY	10
SECTIONS	12
INSTALLATION GUIDELINES	20
APPLICATIONS	26
TABLE OF PERFORMANCE	27

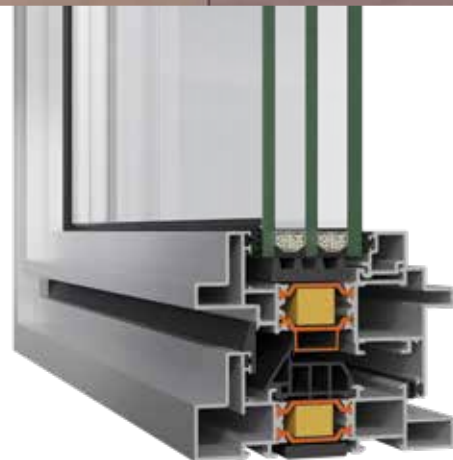

SMARTIA S67 URBAN is a new hinged insulated system that ideally combines industrial look and top performances in terms of air and water tightness and thermal insulation.

- / Steel Look aesthetics.
- / Basic system depth 105 mm.
- / Available in two versions: Standard and High.
- / High thermal insulation ($U_i \geq 1,9$).
- / 3 levels of watertightness with the use of EPDM gaskets.
- / Capable of triple glazing (up to 44 mm).
- / Both Concealed and Standard hinges .
- / Grid windows can be fabricated with a combination of T-profiles and muntins, fully imitating steel look image.

Technical characteristics

Visible aluminium face width	85mm
Frame height	40mm
Frame width	105mm
Sash height	65mm
Sash width	105mm
Sash weight	up to 180kg
Glazing	up to 44 mm
Insulation	polyamides 30mm width, NRG Bar, PE insulation foam

Unique aesthetics



Real Steel Look appearance

The intense protrusions of the surfaces give SMARTIA S67 URBAN an authentic steel look, fully aligned with the trends of modern architecture

Furthermore, these protrusions are applied not only in external but also in **internal** surface (not common to similar competitor's systems), enhancing the application of industrial look in the interior design.

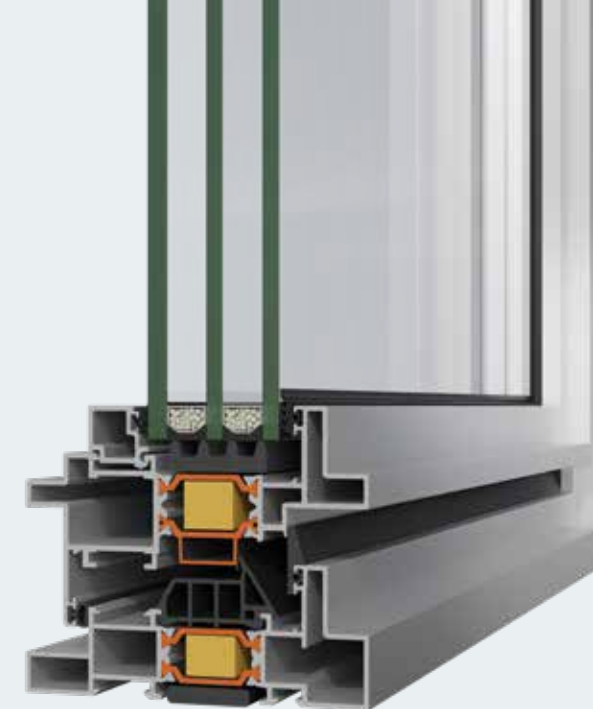

Grid Like Pattern

A Georgian Style appearance can be achieved, using both T-profiles (54 mm) and muntins (27 mm) in all possible combinations. Muntins can be installed with the use of silicon and adhesive tape.

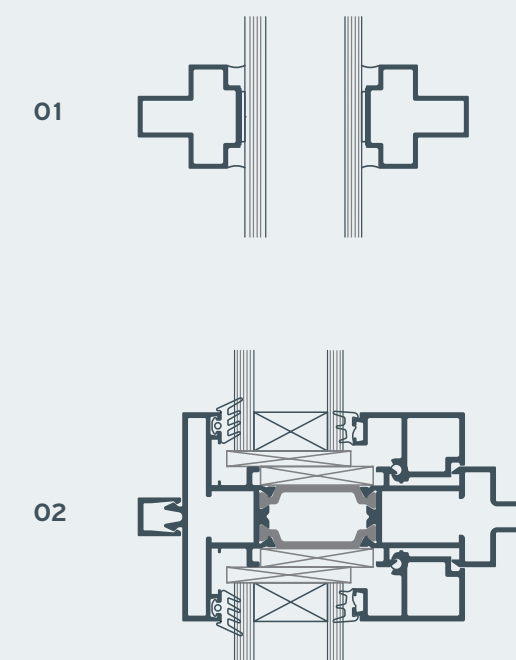



Minimalism

By using a low frame of 40 mm height, we achieve a visible aluminium width of 85 mm, highlighting minimalism, the essence of Industrial look.

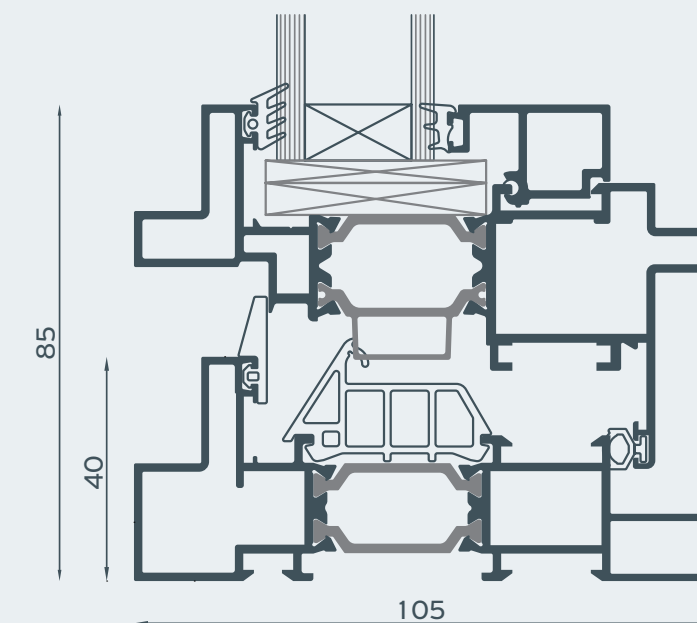

Locking system

SMARTIA S67 URBAN uses European Groove mechanism and can be combined either with concealed hinges, providing a smooth surface to the outer performance, or standard hinges for a more competitive option.

Insulation and sealing technology



No	Material	Version
1	30mm width fiberglass reinforced polyamides	Standard & Hi
2	Multi chamber EPDM central gasket that contributes to system's high performances	Standard & Hi
3	NRG Bar, a premium performance rigid insulation profile, that improves U_f values up to 20%.	Hi
4	Insulation foam profile, installed perimetrically under the glazing pane and frame, improving even more thermal efficiency.	Hi

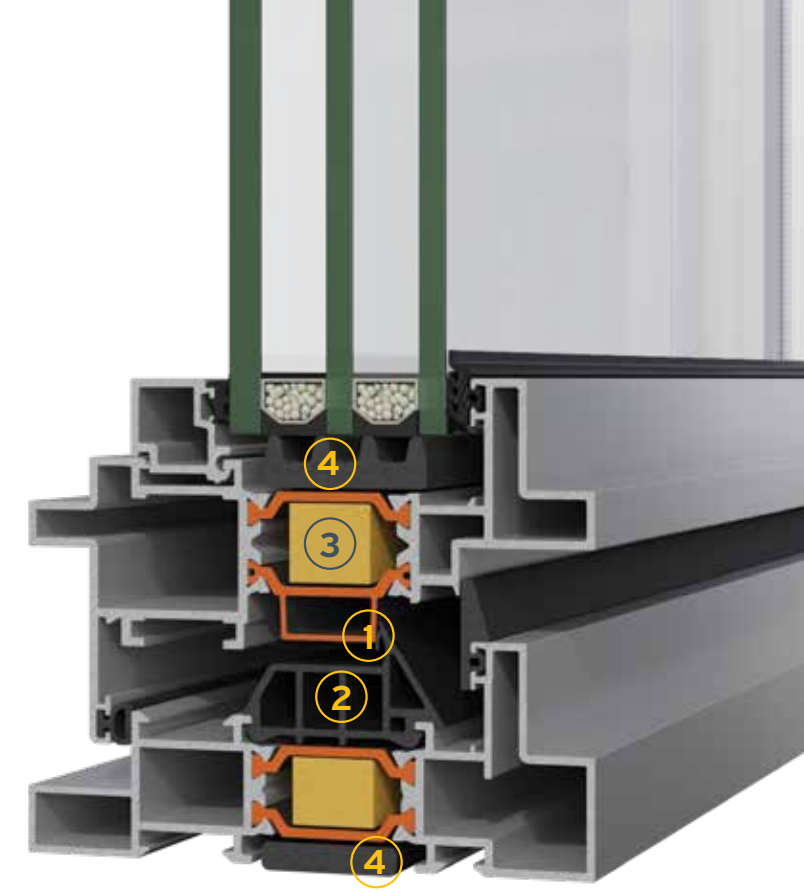

3 level of sealing

Using EPDM gaskets, S67 URBAN offers a three-level sealing, making the system totally protect from heavy weather conditions.

- 1 EPDM extruded central gasket, which ensures high performance sealing.
- 2 EPDM frame gasket.
- 3 EPDM sash gasket.

Glazing

Having a wide range of glazing beads, S67 URBAN can satisfy every need for both double and triple glass infill, achieving, at the same time, high thermal efficiency.

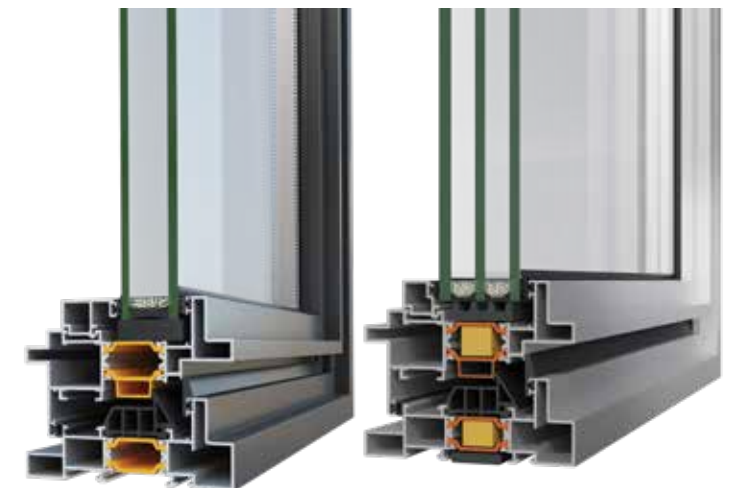

S67 Urban Versions

By choosing among available accessories, SMARTIA S67 URBAN provides two different levels of thermal insulation: Standard and Hi.

STANDARD



- / Multi chamber EPDM Central Gasket
- / One chamber EPDM wedge gasket

HI



- / Multi chamber EPDM Central Gasket
- / One chamber EPDM wedge gasket
- / PE Insulation Foam
- / Energy Bar

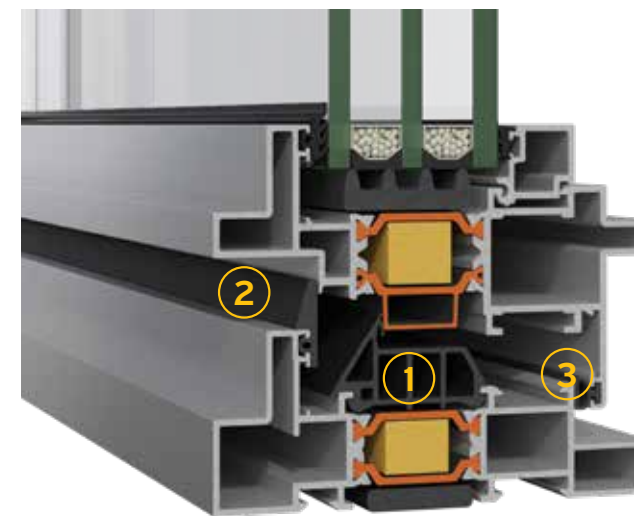

Sections

01

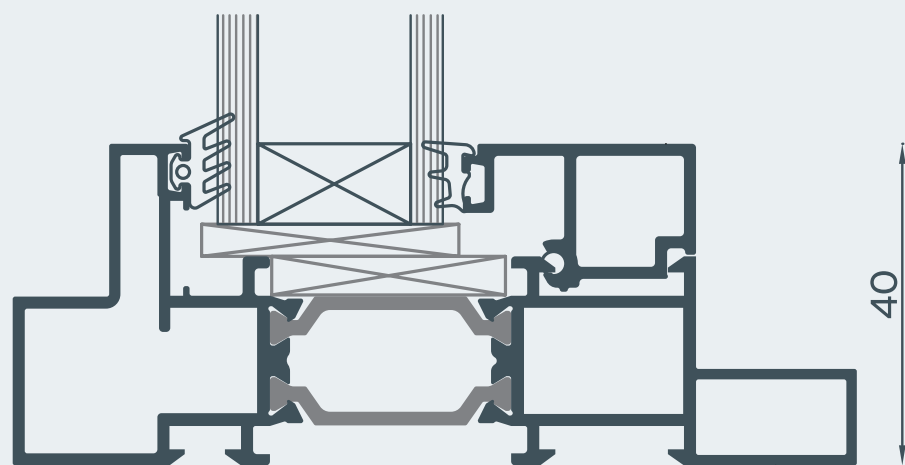
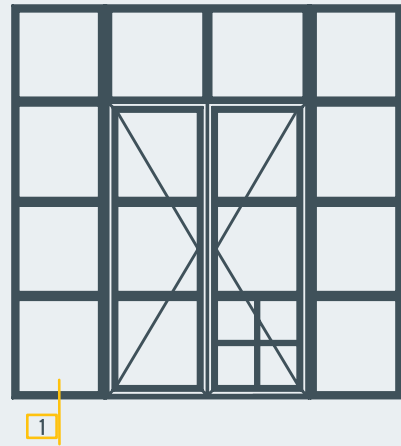

02

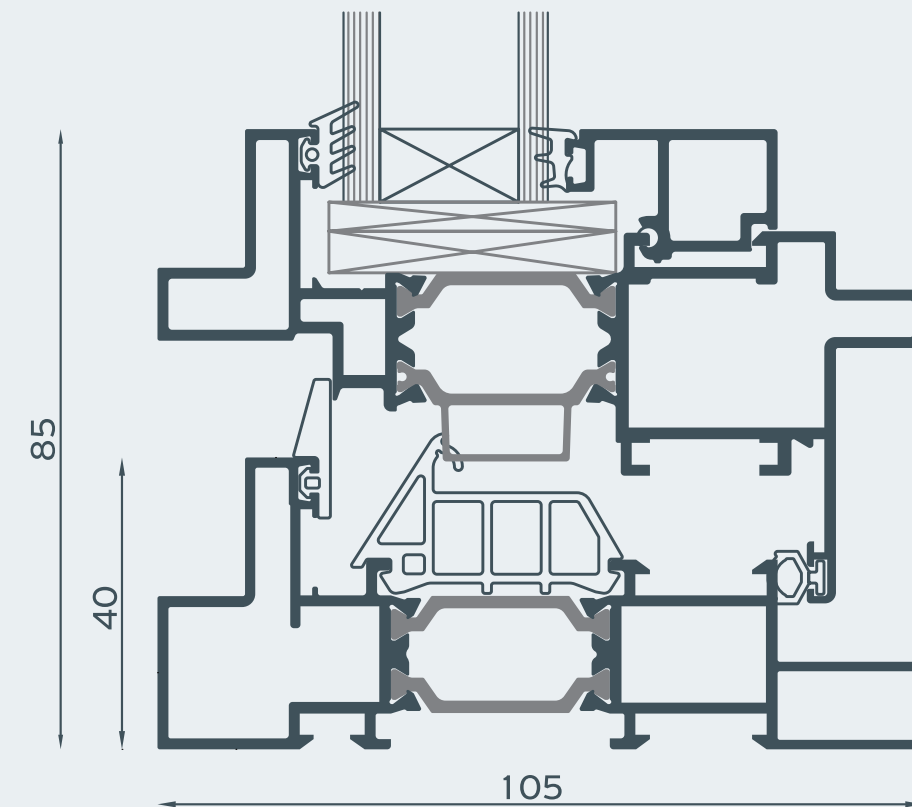
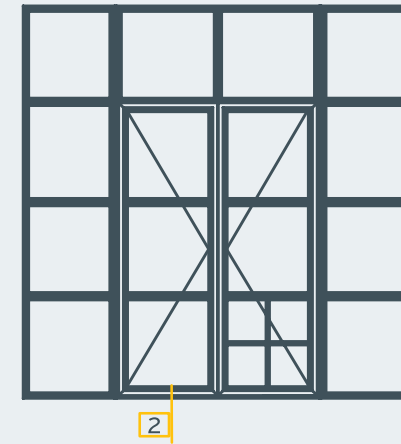

03

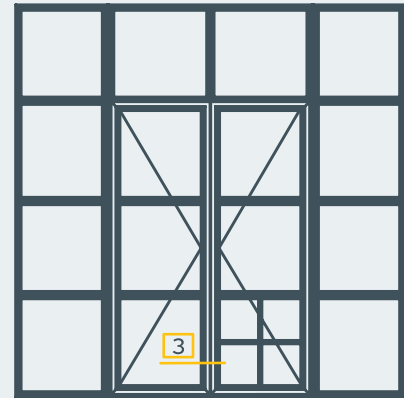

135

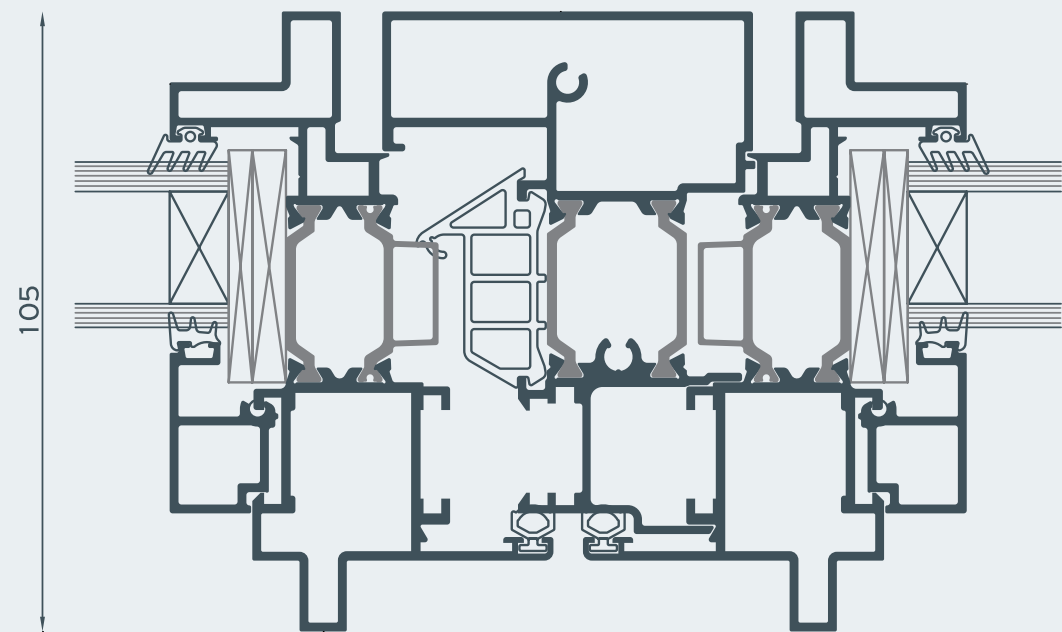

04

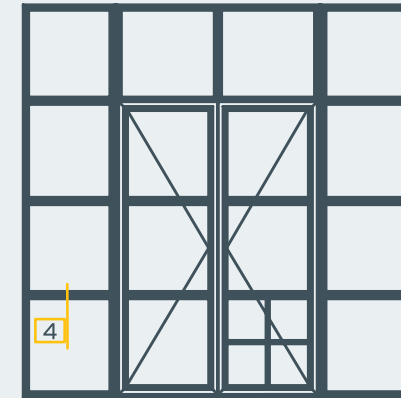

54

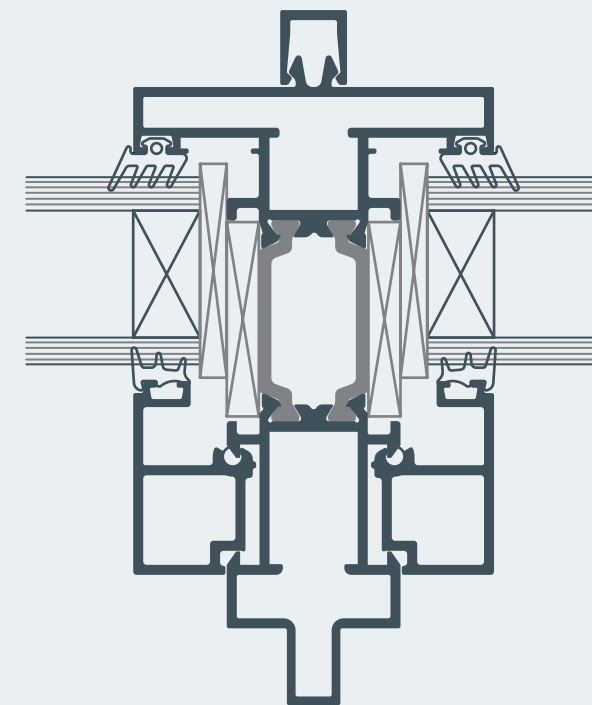

05

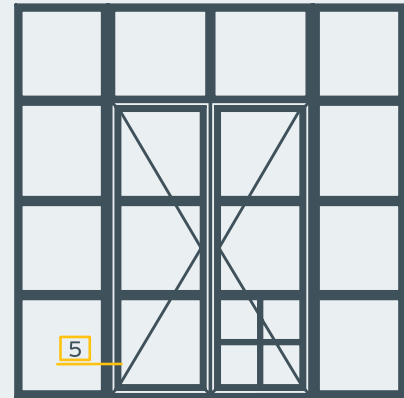

129,41

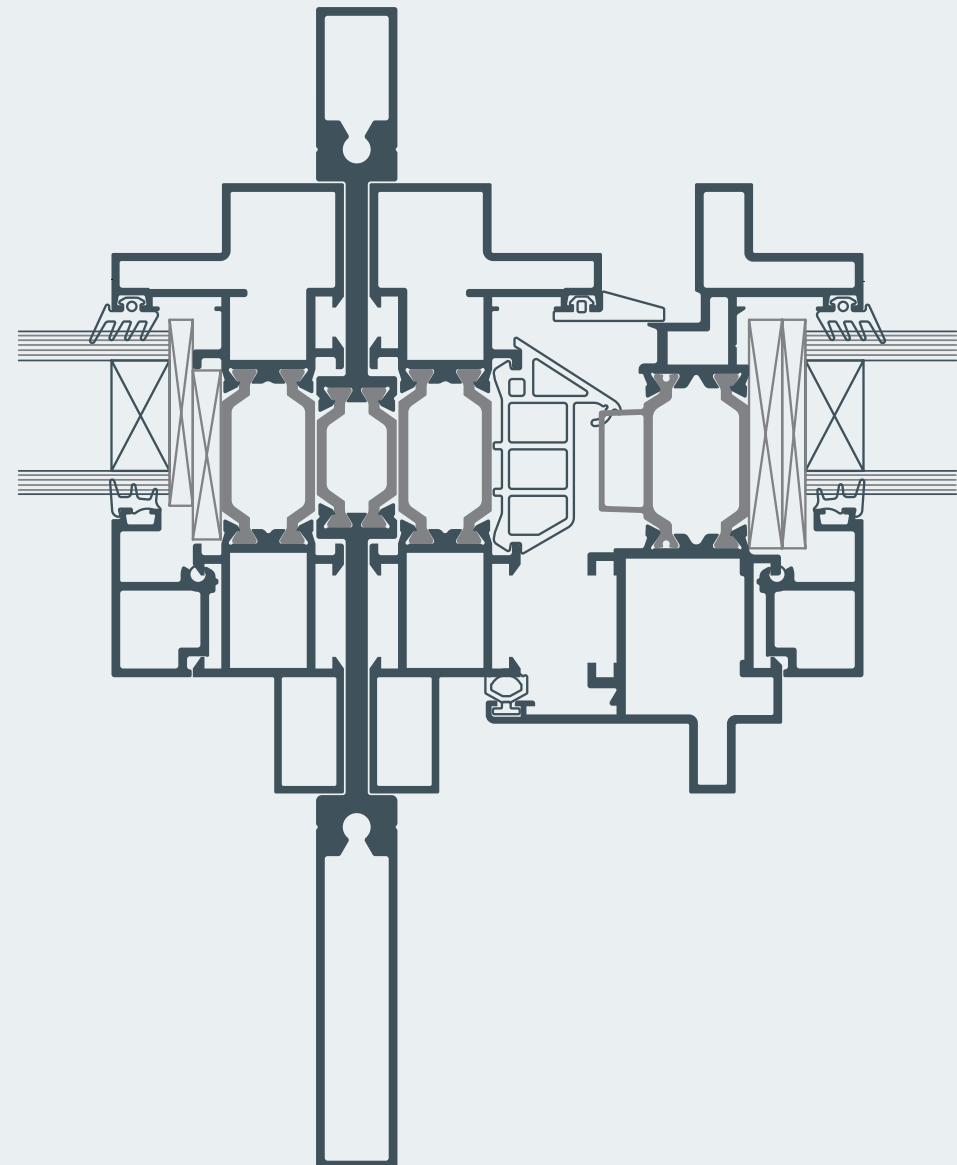

06

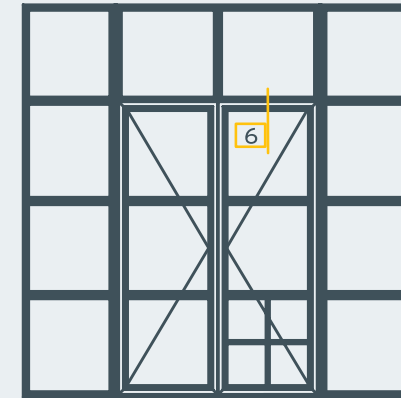

99

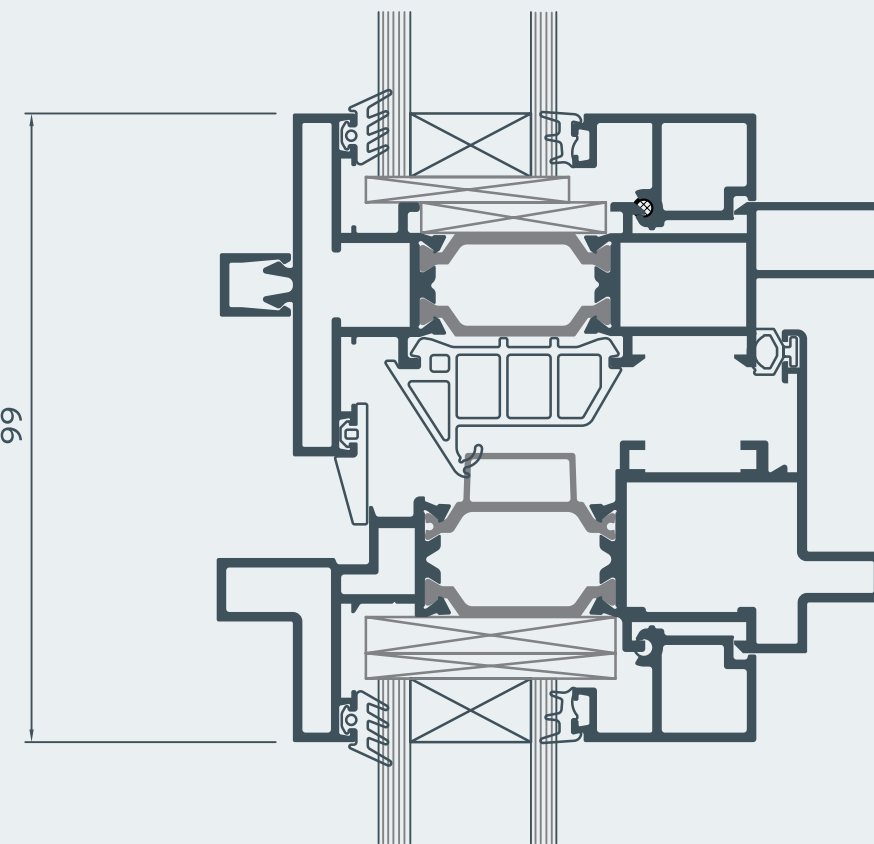

07

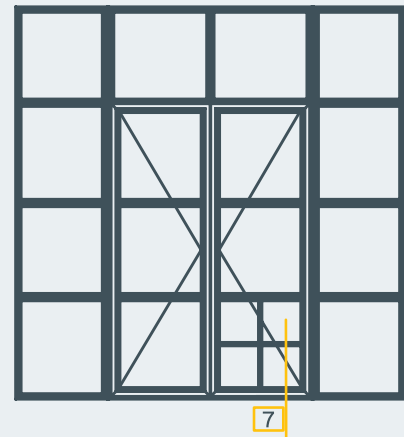

25,7 25,7

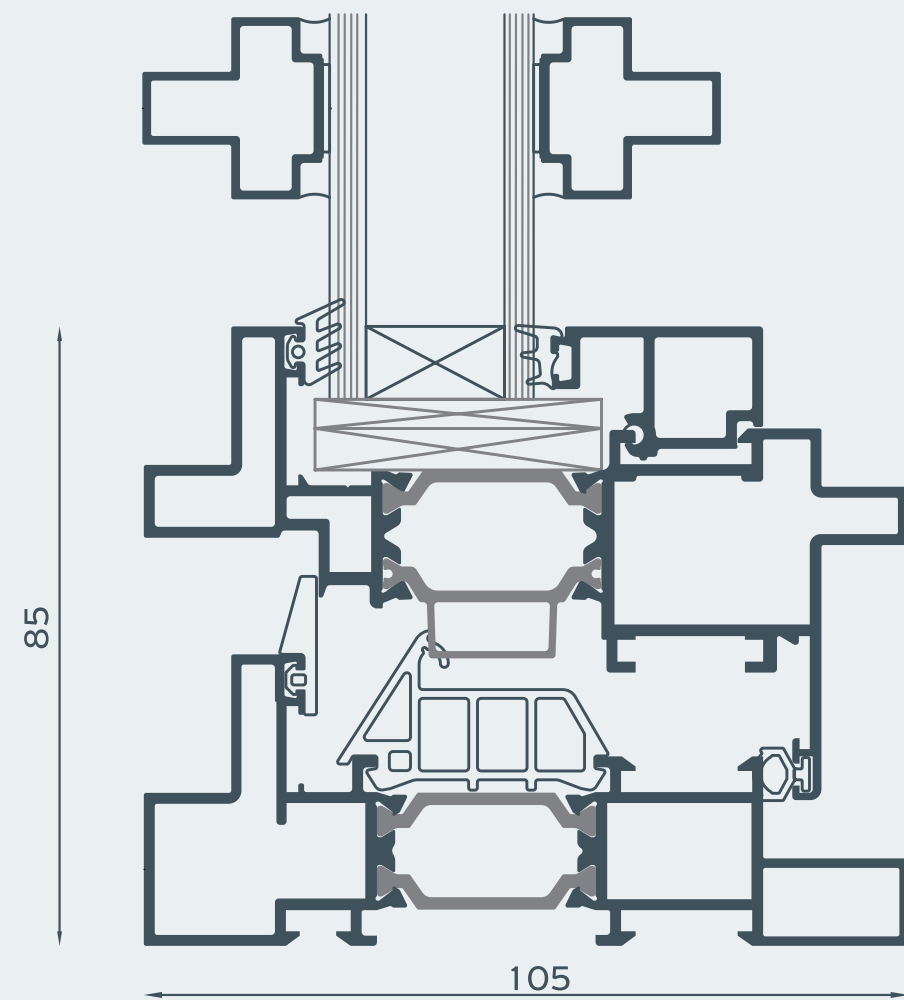

08

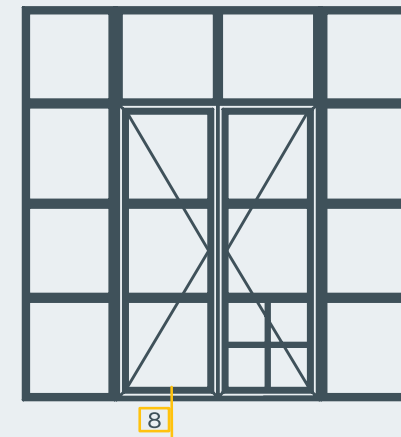



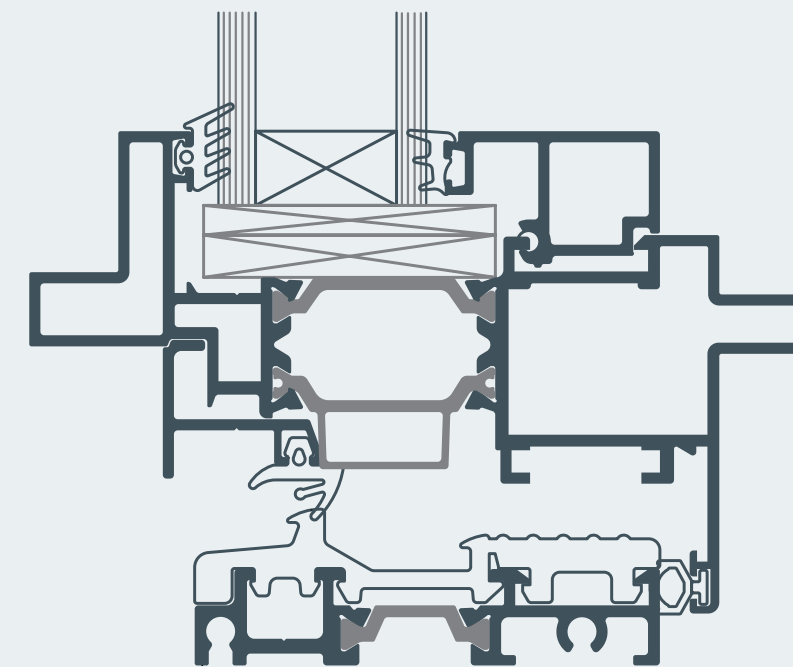





105



Installation

External insulation
installation in the middle of the wall

Side section

	Air-Water Vapor Barrier Tape
	Backer Rod
	Hybrid Sealant or Neutral Silicone
	Polyurethane Foam
	Steel frame anchor
	Window sill profile
	PVC sill profile
	Aluminium profile

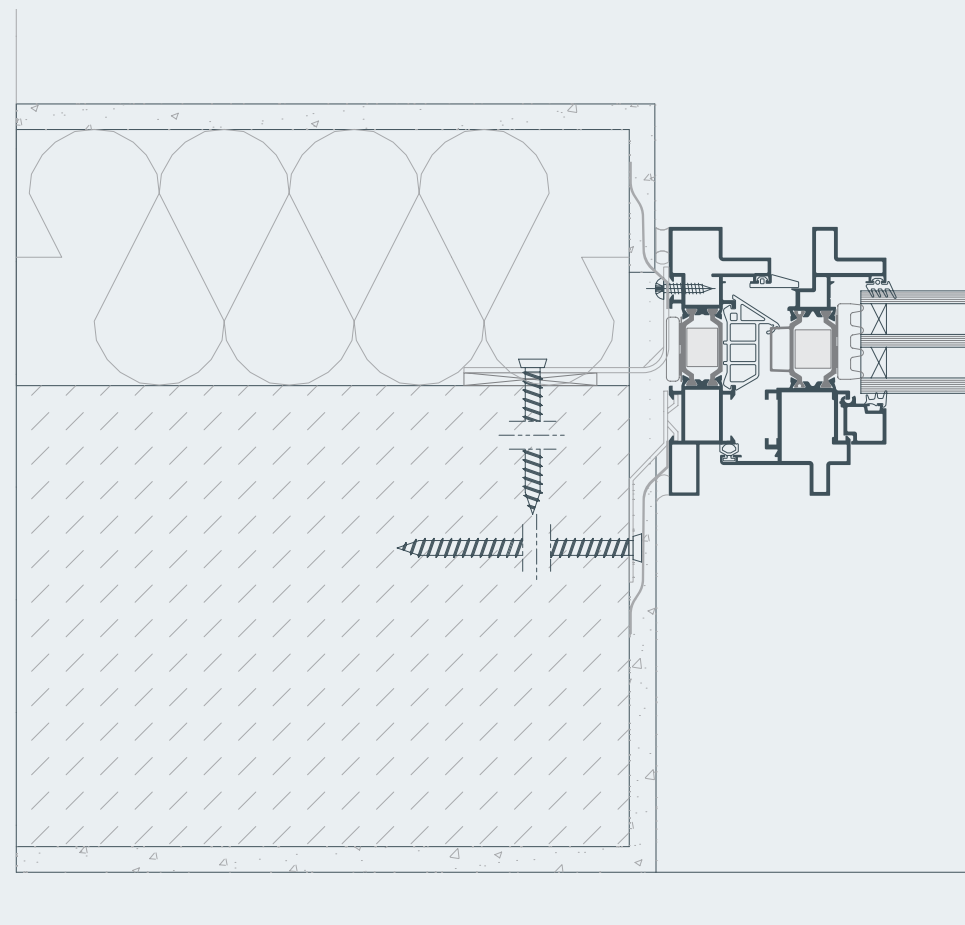

Bottom section A

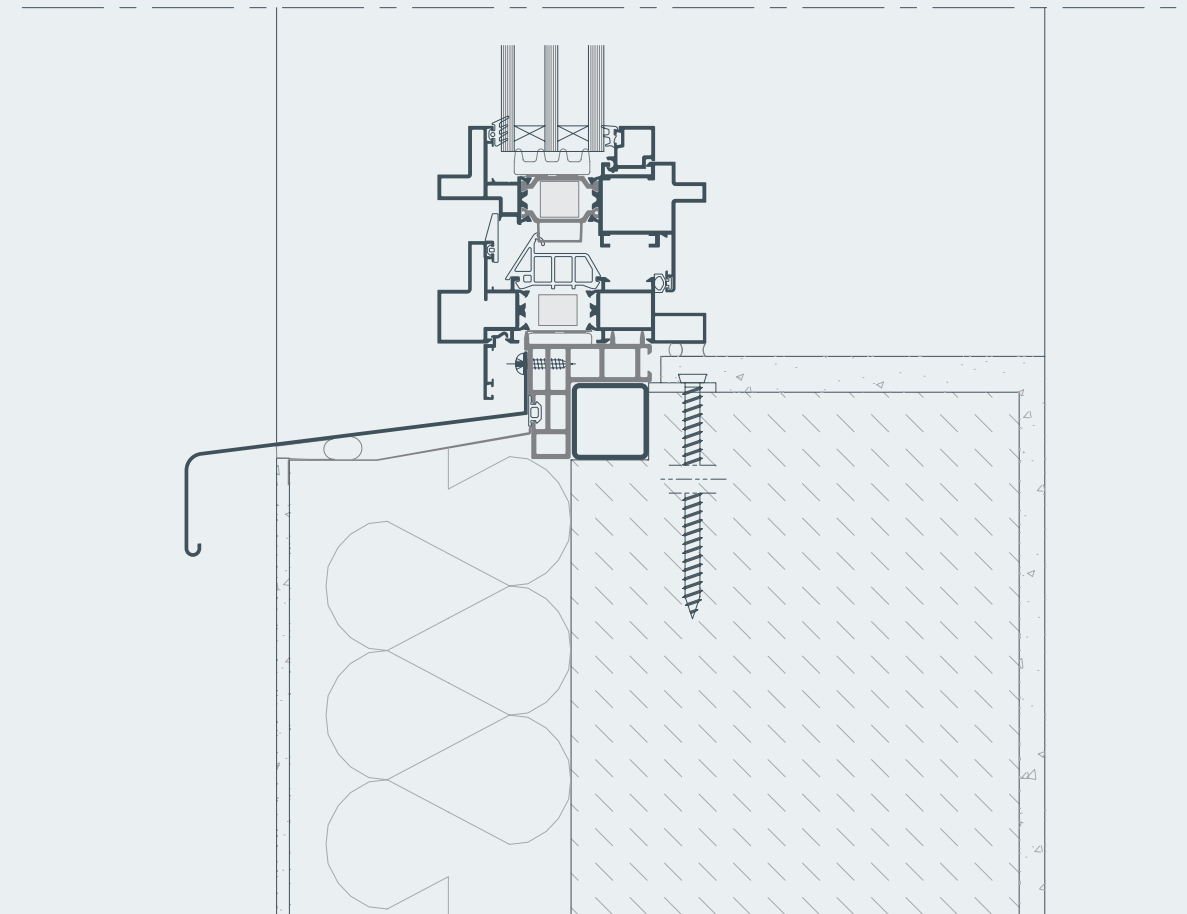



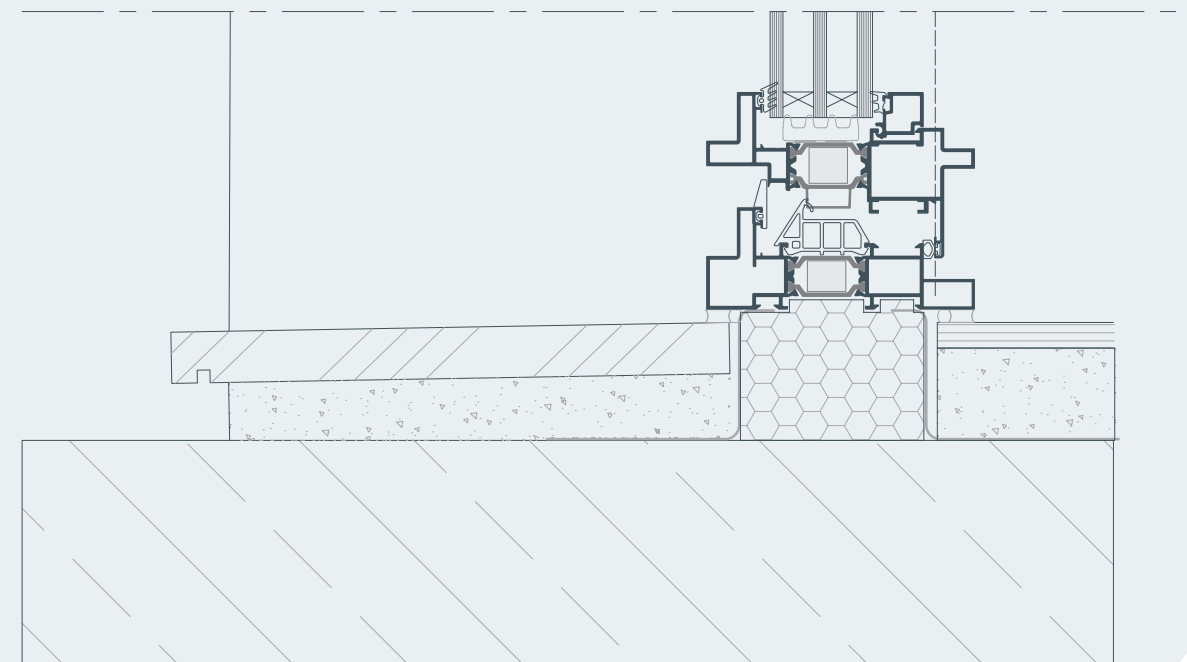





Bottom section B



External insulation
installation in the bottom of the wall

Side section

	Air-Water Vapor Barrier Tape
	Backer Rod
	Hybrid Sealant or Neutral Silicone
	Polyurethane Foam
	Steel frame anchor
	window sill profile
	PVC sill profile
	Aluminium profile

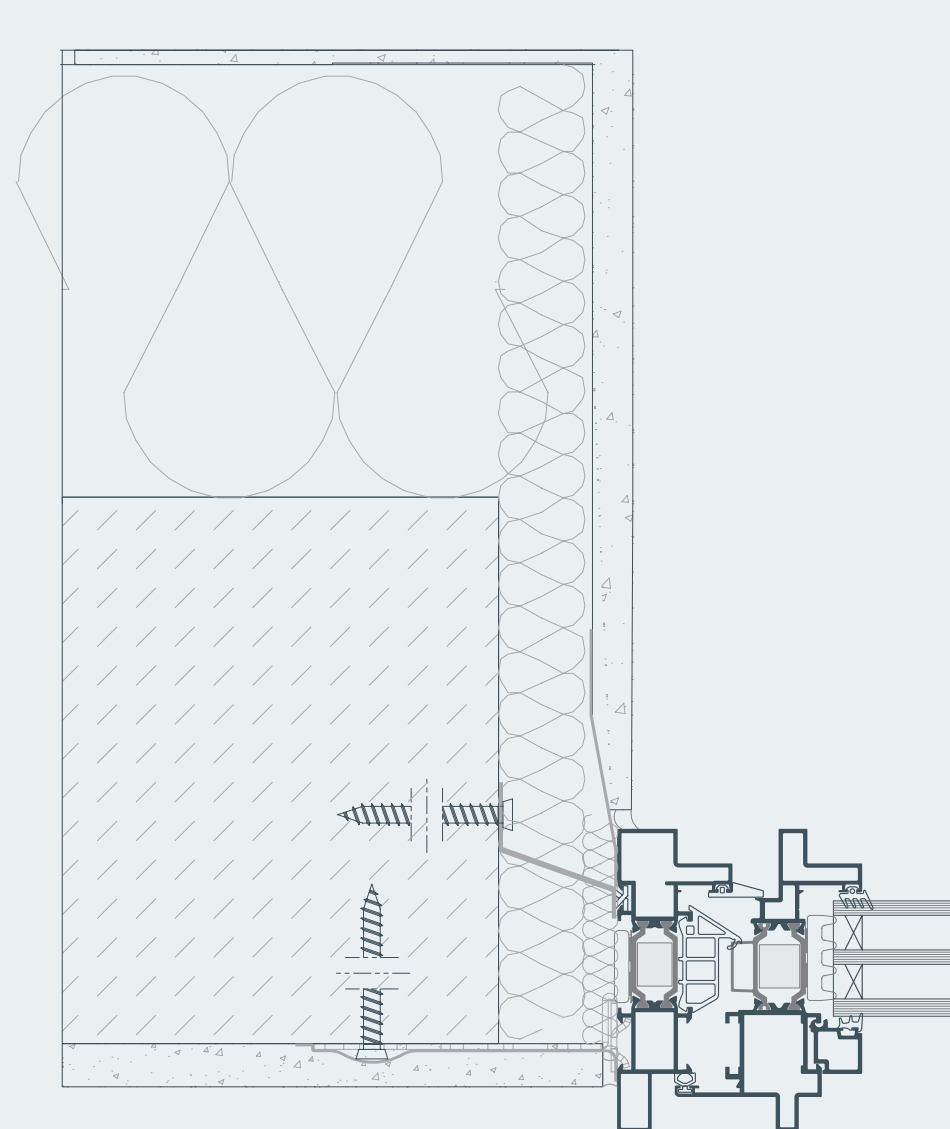

Bottom section A

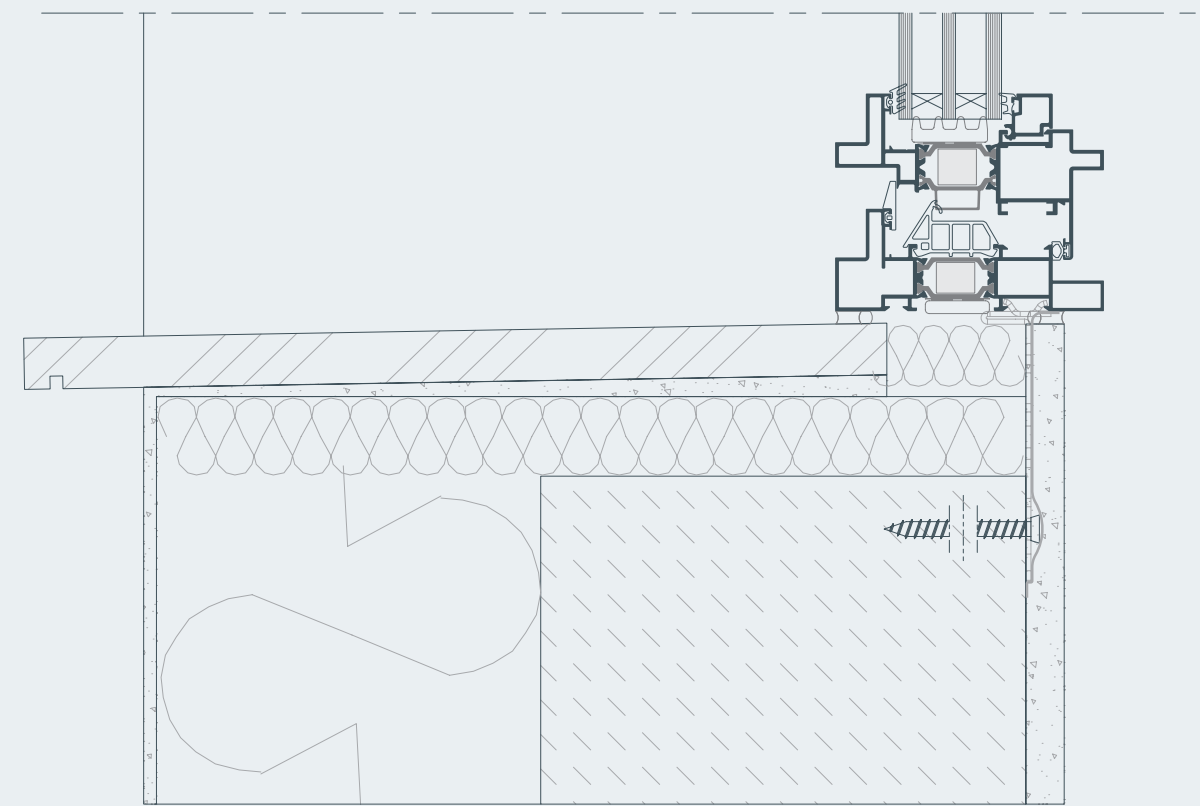



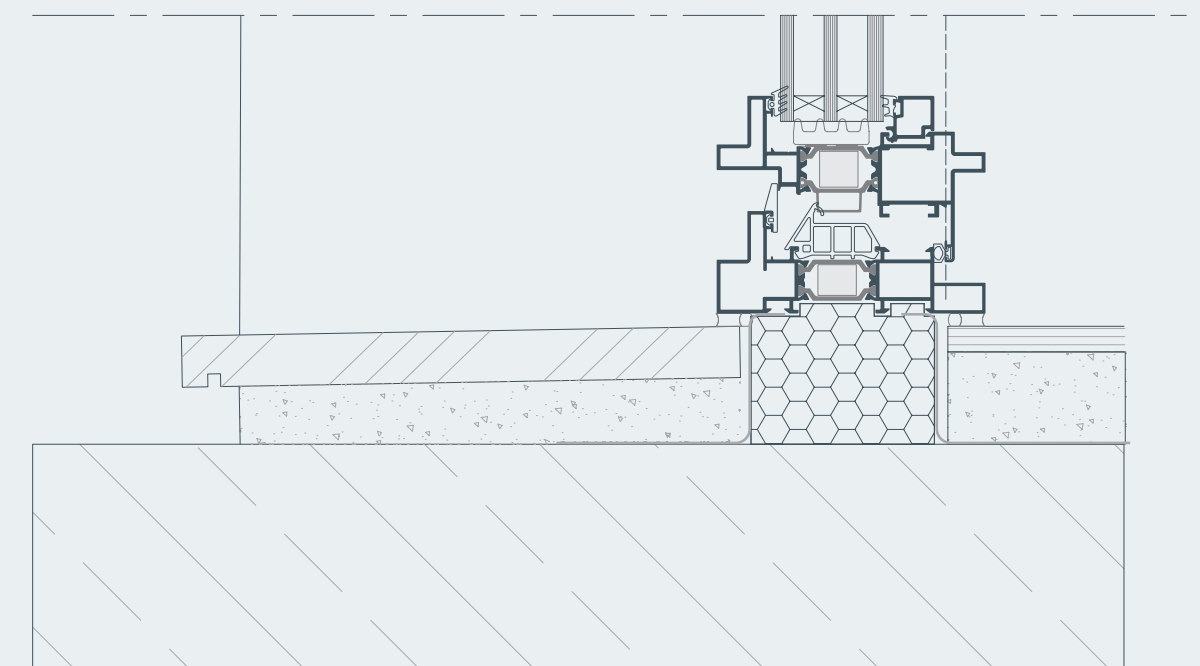





Bottom section B



Intermediate insulation installation in the middle of the wall

Side section

	Air-Water Vapor Barrier Tape
	Backer Rod
	Hybrid Sealant or Neutral Silicone
	Polyurethane Foam
	Steel frame anchor
	window sill profile
	PVC sill profile
	Aluminium profile

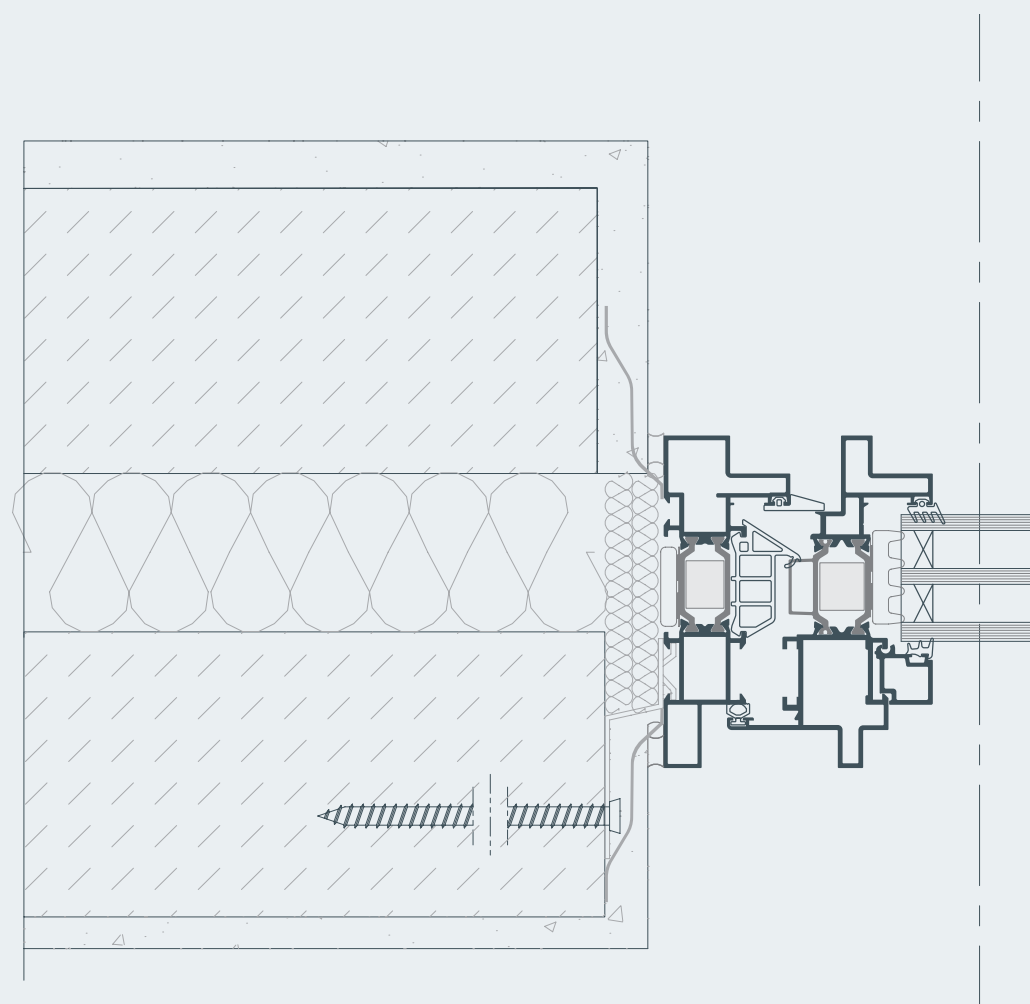

Bottom section

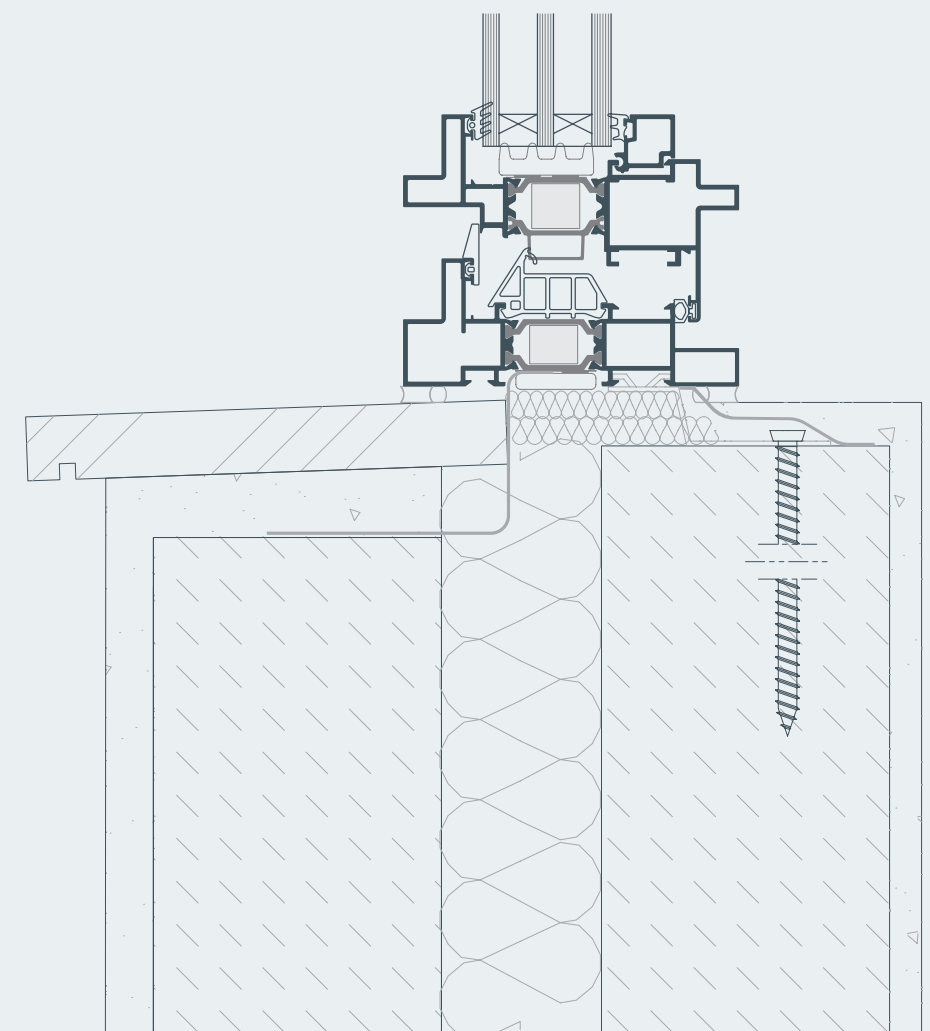

Applications

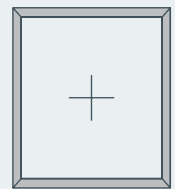

1 fixed light

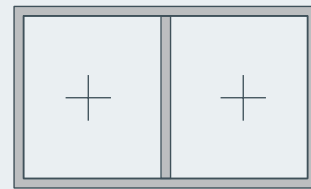

2 fixed lights



4 fixed lights

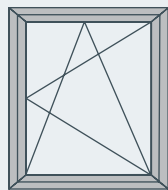

Single side-hung casement,
tilt and turn

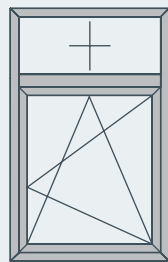

Single side-hung casement,
tilt and turn with fixed light

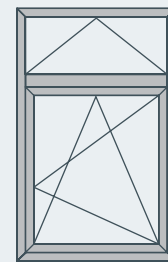

Single side-hung casement,
tilt and turn with tilt light

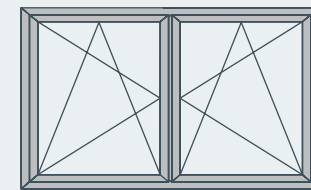

Double side-hung casement,
tilt and turn

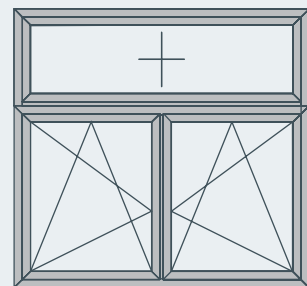

Double side-hung casement,
tilt and turn with fixed light

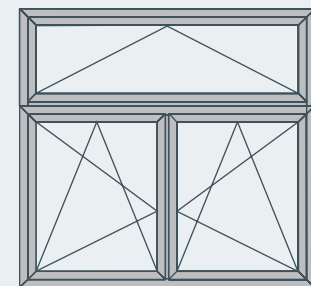

Double side-hung casement,
tilt and turn with tilt light

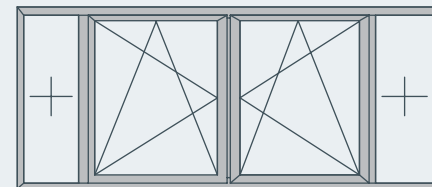

Double side-hung casement,
tilt and turn with side lights

Table of performance

CERTIFICATION

Water tightness
EN 12208

Air permeability
EN 12207

Wind load resistance,
max. test pressure
EN 12210

Wind load resistance
to frontal deflection
EN 12210

CLASSIFICATION

1A (0 Pa)	2A (50 Pa)	3A (100 Pa)	4A (150 Pa)	5A (200 Pa)	6A (250 Pa)	7A (300 Pa)	8A (450 Pa)	9A (600 Pa)	E750 (750 Pa)
1		2			3			4	
1 (400 Pa)		2 (800 Pa)		3 (1200 Pa)		4 (1600 Pa)		5 (2000 Pa)	
A (≤1/150)				B (≤1/200)				C (≤1/300)	

THERMAL PERFORMANCE

	Dimensions in mm (W x H)	U _w in W/m ² K (U _g =0,6)	U _w in W/m ² K (U _g =0,8)	U _w in W/m ² K (U _g =1,0)
1 sash Hi	1000 x 2200	1,06	1,19	1,64
2 sashes Hi	1500 x 2200	1,14	1,29	1,67
1 sash Standard	1000 x 2200	1,21	1,34	1,78
2 sashes Standard	1500 x 2200	1,31	1,46	1,84

**ALUMIL
HEAD OFFICES
& SHOWROOM - THESSALONIKI**

Goçousi 8, Efkarpia
Thessaloniki - GR 56429
Tel.: +30 2313 011000
Fax: +30 2310 692473
E-mail: info@alumil.com

**ALUMIL
HEADQUARTERS**

Kilkis Industrial Area
Kilkis - GR 61100
Tel.: +30 23410 79300
Fax: +30 23410 71988
Email: info@alumil.com



alumil

www.alumil.com